

ATyS Bypass



www.socomec.com
To download brochures,
catalogues and technical manuals.

GENERAL SAFETY INSTRUCTIONS

- This manual provides instructions on safety, connections and operation of the following switching transfer system: the enclosed ATS By-Pass solution.
- This system must always be installed and commissioned by qualified and approved personnel.
- Maintenance and servicing operations must be performed by trained and authorised personnel.
- The information provided in this manual is subject to change, and is non-contractual.
- This manual must be kept in a place so as to be available to anyone likely to need it.
- This system meets the European Directives ruling this type of product. It has the CE marking.
- This equipment have been built as per the applicable IEC standards, that is:
 - IEC 61439-2: low voltage equipment
 - IEC 60529: Degrees of protection provided by enclosures (IP code)
- The products complies with the following standards:
 - IEC 60947-6-1: Multiple function equipment - transfer connection equipment
 - IEC 60947-3: low voltage devices, disconnection switches
 - GB 14048-11

CONTENTS

1. INTRODUCTION	4
1.1. General introduction	4
1.2. The ATS By-Pass range	5
1.3. Equipment presentation	6
1.4. Optional accessories	8
2. TECHNICAL CHARACTERISTICS	9
2.1. Mechanical characteristics	9
2.2. Electrical characteristics	11
2.3. Environmental conditions	12
2.3.1. IP Rating	12
2.3.2. Operation	12
3. INSTALLATION	13
3.1. Handling	13
3.2. Equipment fixing	15
3.3. Connection of control-command circuit / Auxiliary	16
3.4. Connection of power circuit	20
3.5. Accessories fitting	23
3.6. Programming	25
3.6.1. ATyS p M ($\leq 125A$)	25
3.6.2. Test modes	28
3.6.3. ATyS p ($>125 A$)	28
3.6.4. Programming D20	34
3.6.4.1. Programming example	35
3.6.4.2. Architecture of the programming menu ATyS D20	36
3.7. SoLive for Atys Bypass	42

4. OPERATION	49
4.1. Equipment presentation	49
4.2. Exploitation: Double Line range	49
4.2.1. Initial position	49
4.2.2. Normal function	49
4.2.3. By-Pass Function	50
4.2.4. Test function	50
4.3. Exploitation: Single Line range	51
4.3.1. Initial position	51
4.3.2. Normal function	51
4.3.3. By-Pass Function	52
4.3.4. Test function	52
4.3.5. Isolation of the ATS	52
4.4. Visualization	53
4.5. Communication	55
4.5.1. ATyS p M	55
4.5.2. ATyS p	59
4.5.2.1. Metrology Affected by current and voltage transformers	60
4.5.2.2. Energy	60
4.5.2.3. Metrology not affected by current and voltage transformers	61
4.5.2.4. Input/Output state	61
4.5.2.5. Network setting	62
4.5.2.6. Hour/Date setting	62
4.5.2.7. Ethernet module interface	62
4.5.2.8. Action system	63
4.5.2.9. Status	63
4.5.2.10. Engine exerciser - custom time range status	65
4.5.2.11. Measurement table (no CT/VT affected)	65
4.5.2.12. Energies and time meters	66
4.5.2.13. Timers state	67
4.5.2.14. Option module state	69
4.5.2.15. Commands	70
4.5.2.16. User commands	70
4.5.2.17. Setup timer	71
4.5.2.18. Setup user's power threshold	72
4.5.2.19. Setup network	72
4.5.2.20. Setup Input/Output	74
4.5.2.21. Communication settings	85
4.5.2.22. Product counters	86
4.5.2.23. Output set	86
4.5.2.24. Input state	87
4.5.2.25. Setup pulse and 0/4-20mA option modules	88
4.5.2.26. Setup custom time	90
4.5.2.27. Custom time validate	91
4.5.2.28. Detailed events	91
5. PREVENTATIVE MAINTENANCE	95
6. PROCEDURE FOR EXTRACTING THE AUTOMATIC SWITCH	95
6.1. 40 to 125 A	95
6.2. 160 A	95
6.3. 250 A / 400 A / 630 A	96
6.4. Unlocking the door in positions I and II	97

1. INTRODUCTION

1.1. General introduction

The enclosed ATS By-Pass solution, allows on a Normal/Emergency system, to achieve transfers and fully isolate the Automatic Transfer Switch during inspection, test & maintenance period in order to ensure the availability, reliability and redundancy in the power supply. To propose solutions close to customer requests, Socomec have designed two ranges: network/genset or genset/genset (upon request):

The enclosed ATS By-Pass Single Line range.

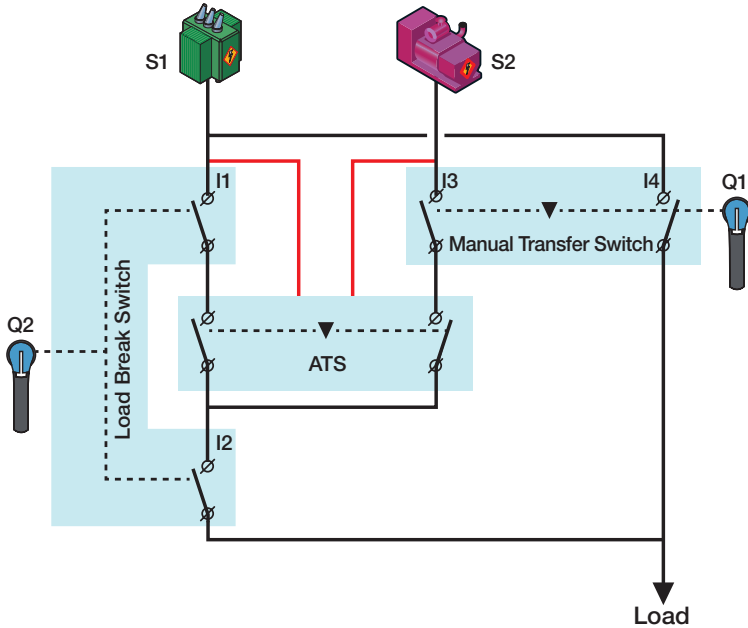

The enclosed ATS By-Pass Double Line range.

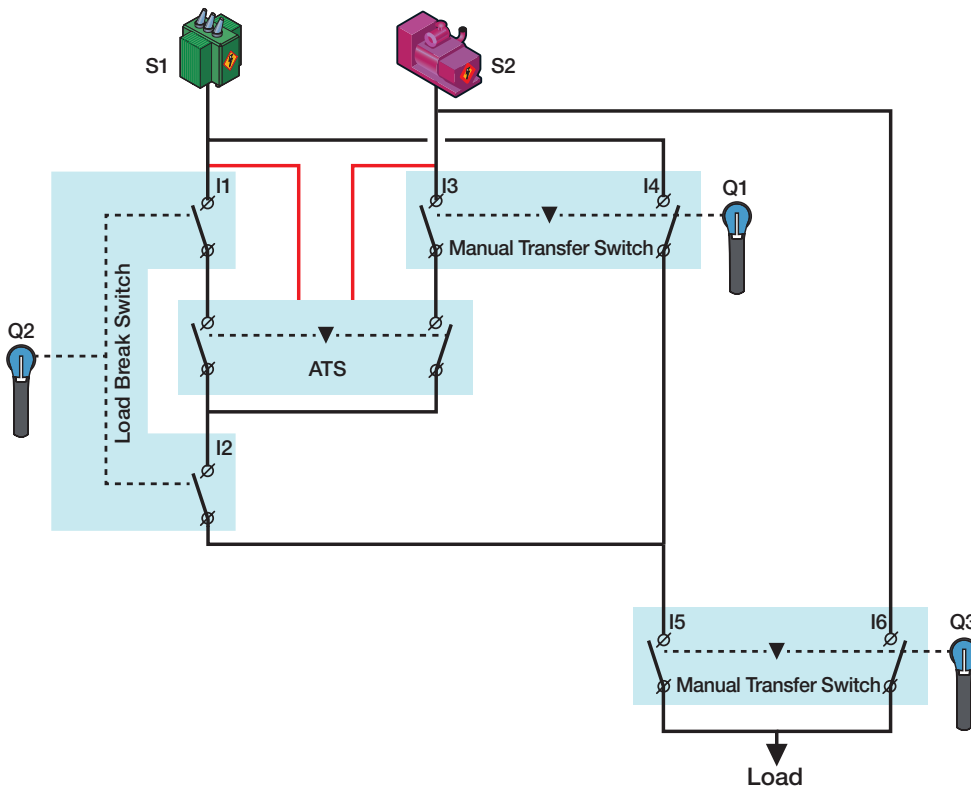

2 types of Automatic Transfer Switch:

From 40 to 125 A: the ATyS p M range



From 160 to 3200 A: the ATyS p range



1.2. The ATS By-Pass range

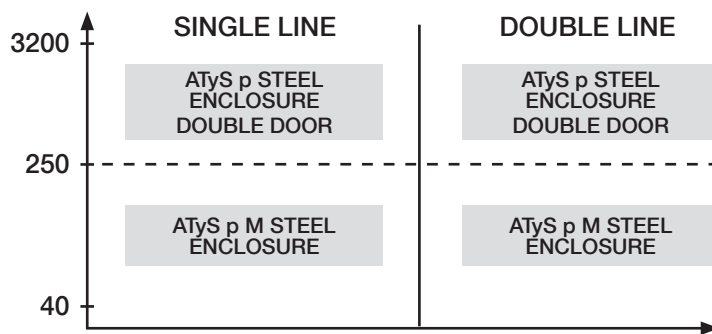

1.3. Equipment presentation

Example 125 A

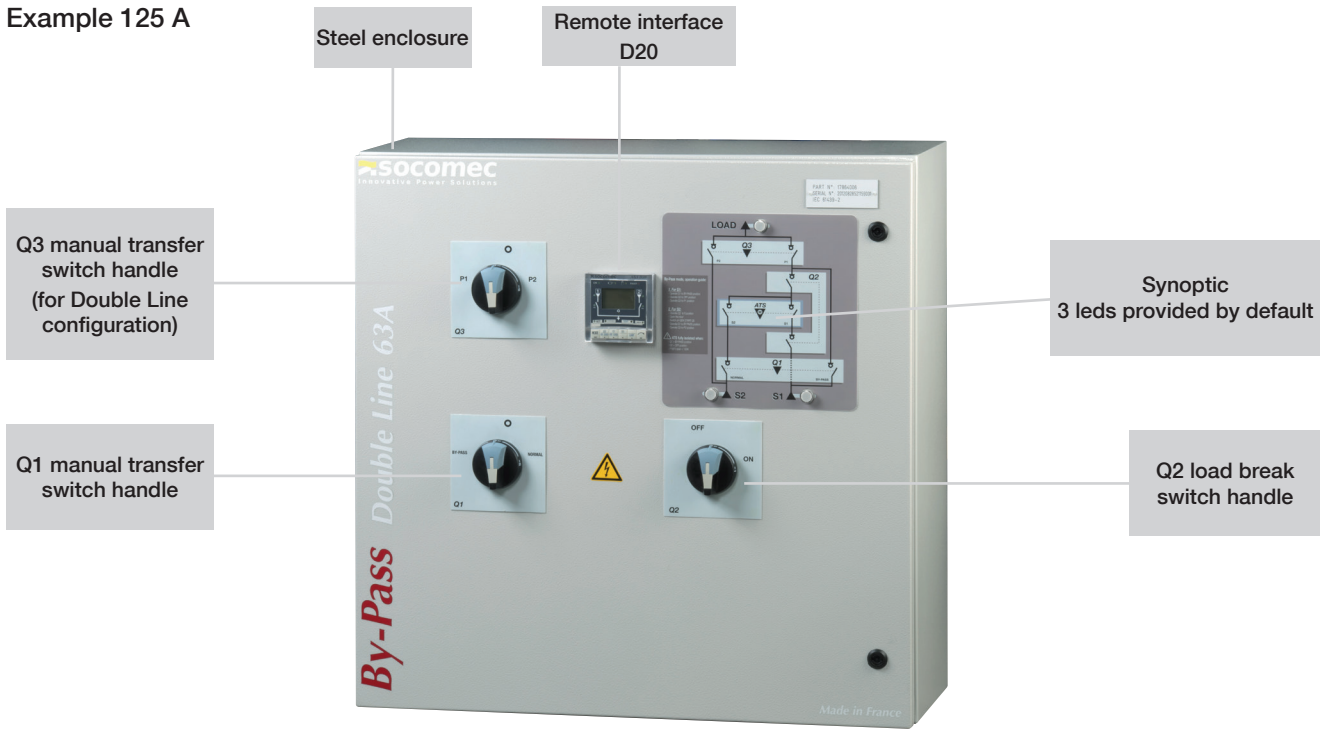



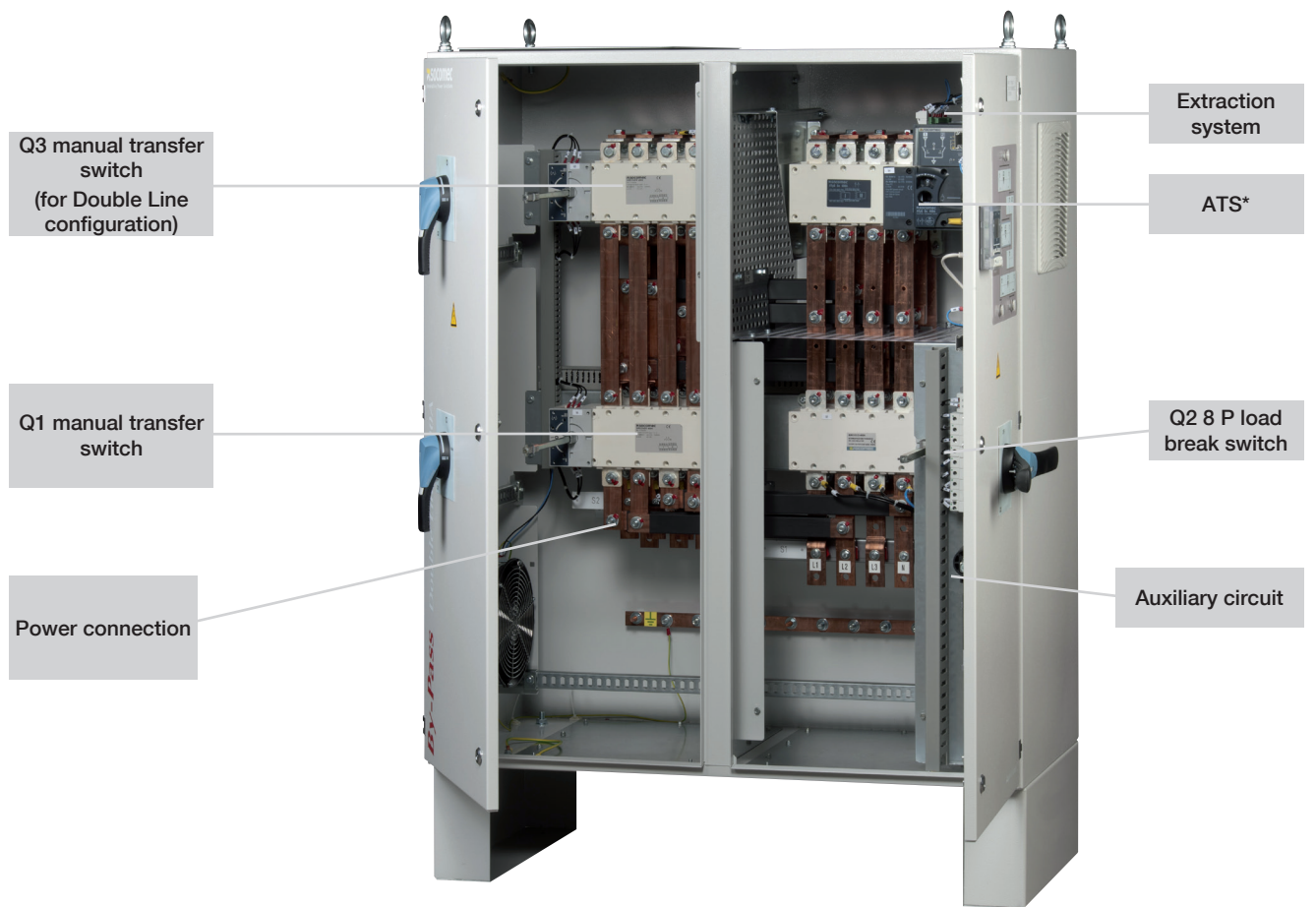
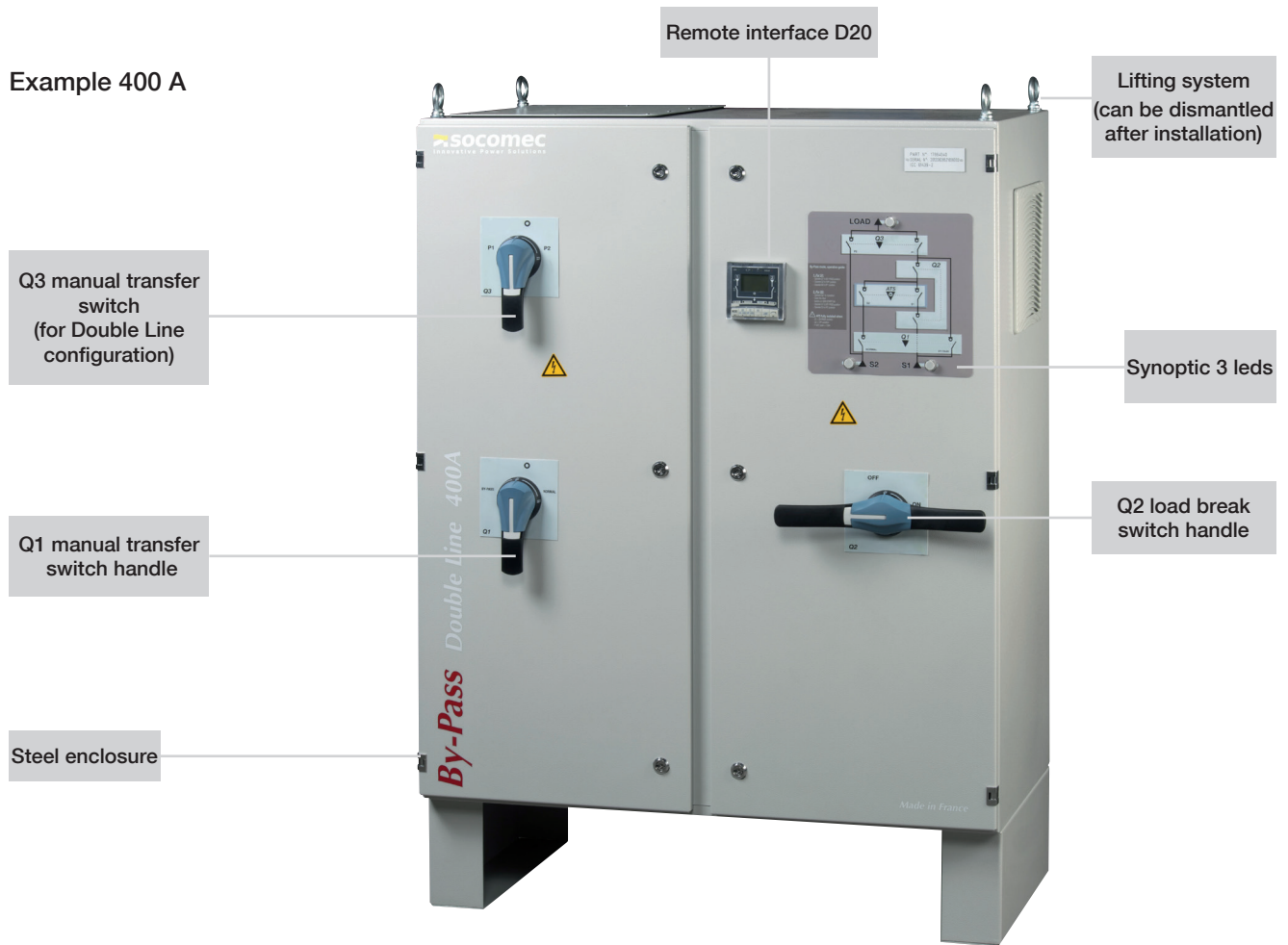

* Automatic Transfer Switch: automatic Transfer Switch

Example 400 A

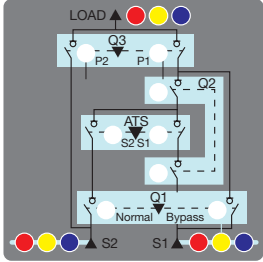

1.4. Optional accessories

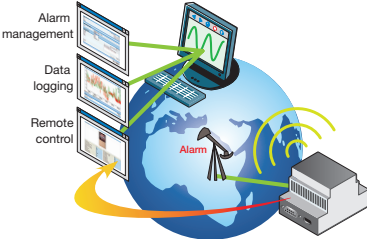
All the below accessories are only factory fitted.

<p>Extension enclosure</p>	<p>From 1200 to 3200A, to facilitate the wiring an extension enclosure can be provided to ensure all the type of connections (BB/TB/TT/BT).</p>		<p>Ref. 1250 A...2000 A 1599 9004 Ref. 2500 A...3200 A 1599 9005</p>
<p>Synoptic (with LED)</p>	<p>For a better visualisation of the mimic diagram 17 LED indicating light can be supplied (positions of the switch, availability of the sources).</p>		<p>Ref. 40...3200 A (SL/DL) 1599 9033 / 1599 9034</p>
<p>Multi-function meter</p>	<p>Will enable the operator to visualize & monitor all the electrical parameters.</p>		<p>Ref. please consult us</p>
<p>Remote ATS By-Pass management</p>	<p>An optional module can be integrated to allow Ethernet communication for the following functions: Alarm management / Data logging / Remote control</p>		<p>Ref. 4899 0400</p>
<p>Protection against atmospheric overvoltage</p>	<p>Will protect the By-Pass equipment against overvoltage: Surgys D40 range - type 2</p>		<p>Ref. 40...125 A 1599 9016 250...400 A 1599 9017 630...3200 A 1599 9018</p>
<p>Tinned busbars</p>	<p>Use for severe environmental conditions.</p>		<p>Ref 1599 9007 ...1599 9013 (depends on the rating)</p>

2. TECHNICAL CHARACTERISTICS

2.1. Mechanical characteristics

From 40 to 160 A

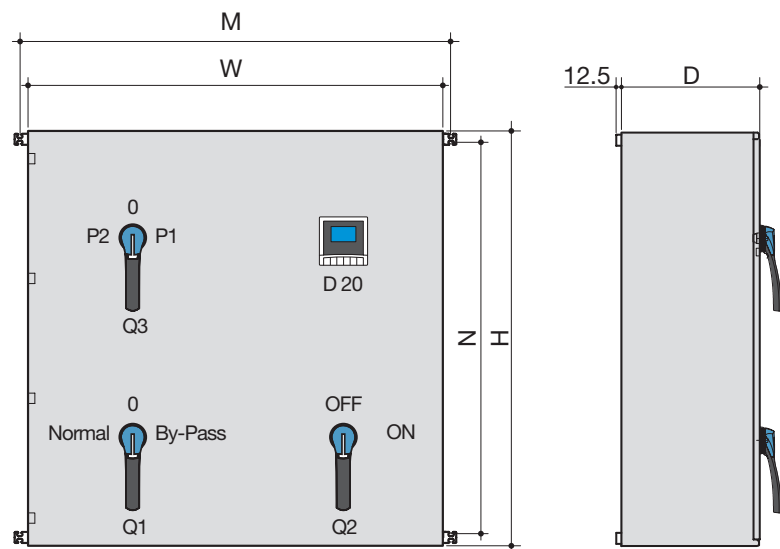

Wall mounting

Rating (A)	H (mm)	W (mm)	D (mm)	M (mm)	N (mm)	Weight (kg)
40	800	800	300	848	752	80
63	800	800	300	848	752	80
80	800	800	300	848	752	80
100	1000	800	300	848	752	80
125	1000	800	300	848	752	80
160	1000	800	400	848	752	80

From 250 to 3200 A

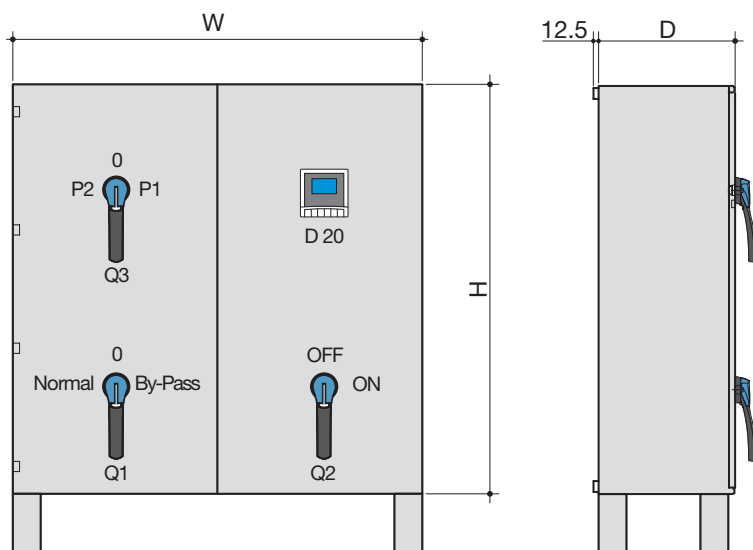

Floor standing

Rating (A)	H (mm)	W (mm)	D (mm)	Weight (kg)
250	1200 ⁽¹⁾	1000	550	180
400	1200 ⁽¹⁾	1000	550	200
630	1600 ⁽¹⁾	1200	600	600
800	1800 ⁽¹⁾⁽²⁾	1600	800	1000
1000	1800 ⁽¹⁾⁽²⁾	1600	800	1000
1250	2360	2000	1000	2000
1600	2360	2000	1000	2000
2000	2360	2000	1000	2500
2500	2360	2000	1000	2500
3200	2360	2000	1000	2500

(1) Add 100 mm for feet.

(2) Add 200 mm for lifting system of the equipment.

2.2. Electrical characteristics

40 to 400 A

Thermal current	40A	63A	80A	100A	125A	160A	250A	400A
@35 °C	40A	63A	80A	100A	125A	160A	250A	400A
@50 °C			70A	94A	120A			390A
@55 °C			65A	88A	112A			370A
@60 °C			60A	60A	84A			105A
Rated operating voltage								
(V)	415	415	415	415	415	415	415	415
Rated insulation voltage								
Power circuit (V)	800	800	800	800	800	800	800	800
Control circuit (V)	300	300	300	300	300	300	300	300
Rated impulse withstand voltage								
Power circuit (kV)	6	6	6	6	6	8	8	8
control circuit (kV)	2,5	2,5	2,5	2,5	2,5	4	4	4
Frequency								
(Hz)	50/60	50/60	50/60	50/60	50/60	50/60	50/60	50/60
Associated fuse rating								
Rating (A)	40	63	80	100	125	160	250	400
Type	gG	gG	gG	gG	gG	gG	gG	gG
Reference	6022 0040	6032 0063	6032 0080	6032 0100	6702 0125	6702 0160	6722 0250	6722 0400
Max. prospective short-circuit current (kA rms) @415V 50Hz								
(kA)	50	50	50	50	50	50	50	35
Power								
Rated power (VA)	6	6	6	6	6			
Power during ATS switching (A)	20	20	20	20	20			
Recommended connection cross-section								
(mm ²)	10	16	25	35	50	70	120	240
Tightening torque (power circuit)								
(Nm)	8,3 (fixing nut M8) 20 (fixing nut M10)	8,3 (fixing nut M8) 20 (fixing nut M10)	8,3 (fixing nut M8) 20 (fixing nut M10)	8,3 (fixing nut M8) 20 (fixing nut M10)	8,3 (fixing nut M8) 20 (fixing nut M10)	8,3 (fixing nut M8) 20 (fixing nut M10)	8,3 (fixing nut M8) 20 (fixing nut M10)	8,3 (fixing nut M8) 20 (fixing nut M10)

630 to 3200 A

Thermal current	630A	800A	1000A	1250A	1600A	2000A	2500A	3200A
@35 °C	630							
@50 °C	615							
@55 °C	590							
@60 °C	560							
Rated operating voltage								
(V)	415	415	415	415	415	415	415	415
Rated insulation voltage								
Power circuit (V)	800	800	800	800	800	800	800	800
Control circuit (V)	300	300	300	300	300	300	300	300
Rated impulse withstand voltage								
Power circuit (kV)	8	8	8	8	8	8	8	8
control circuit (kV)	4	4	4	4	4	4	4	4
Frequency								
(Hz)	50/60	50/60	50/60	50/60	50/60	50/60	50/60	50/60
Associated fuse rating								
Rating (A)	630	800	1000	1250	1600	2000	2500	3200
Type	gG	gG	gG	gG	gG	gG	gG	gG
Reference	6732 0630	6732 0800	6746 1000	6746 1200	67M6 1600	67M6 2000	67M6 2500	67M6 3200
Max. prospective short-circuit current (kA rms) @415V 50Hz								
(kA)	50	50	100	100	100	100	100	100
Power								
Rated power (VA)								
Power during ATS switching (A)								
Recommended connection cross-section								
(mm ²)	2x185	2x240	4x150	4x185	4x240	8x150	8x185	8x240
Tightening torque (power circuit)								
(Nm)	20 (fixing nut M10) 40 (fixing nut M12)	20 (fixing nut M10) 40 (fixing nut M12)	20 (fixing nut M10) 40 (fixing nut M12)	20 (fixing nut M10) 40 (fixing nut M12)	20 (fixing nut M10) 40 (fixing nut M12)	20 (fixing nut M10) 40 (fixing nut M12)	20 (fixing nut M10) 40 (fixing nut M12)	20 (fixing nut M10) 40 (fixing nut M12)

2.3. Environmental conditions

The complete equipment meets the following environmental requirements.

2.3.1. IP Rating

Protection IP41 from 40 to 3200 A (ATyS D20 excepted: IP21).

2.3.2. Operation



Temperature:

- -20 to +35 °C with derating (check the electrical characteristics on previous page)
- +40 to +60 °C with derating (check the electrical characteristics on previous page)



Hygrometry:

- 80% humidity without condensation at +55 °C
- 95% humidity without condensation at +40 °C



Altitude:

- Maximum altitude without derating = 2000 meters



STORAGE:

- Temperature: -20 to +70 °C
- Period: 1 year maximum

3. INSTALLATION

3.1. Handling

Enclosure ≤ 160 A:

Volume and weight enables safe handling when respecting all the rules for handling works.

Enclosure from 250 to 630 A:

Due to weight and volume of enclosures lifting eyes are requested for handling.



Use:

- Insert: M12
- Maximum load per eye: 240 kg at 60°
- Internal diameter of the lifting eye: 30 mm

Raw material:

- Zinc steel



Number of people needed	Wrench to be used
 x 1	 19

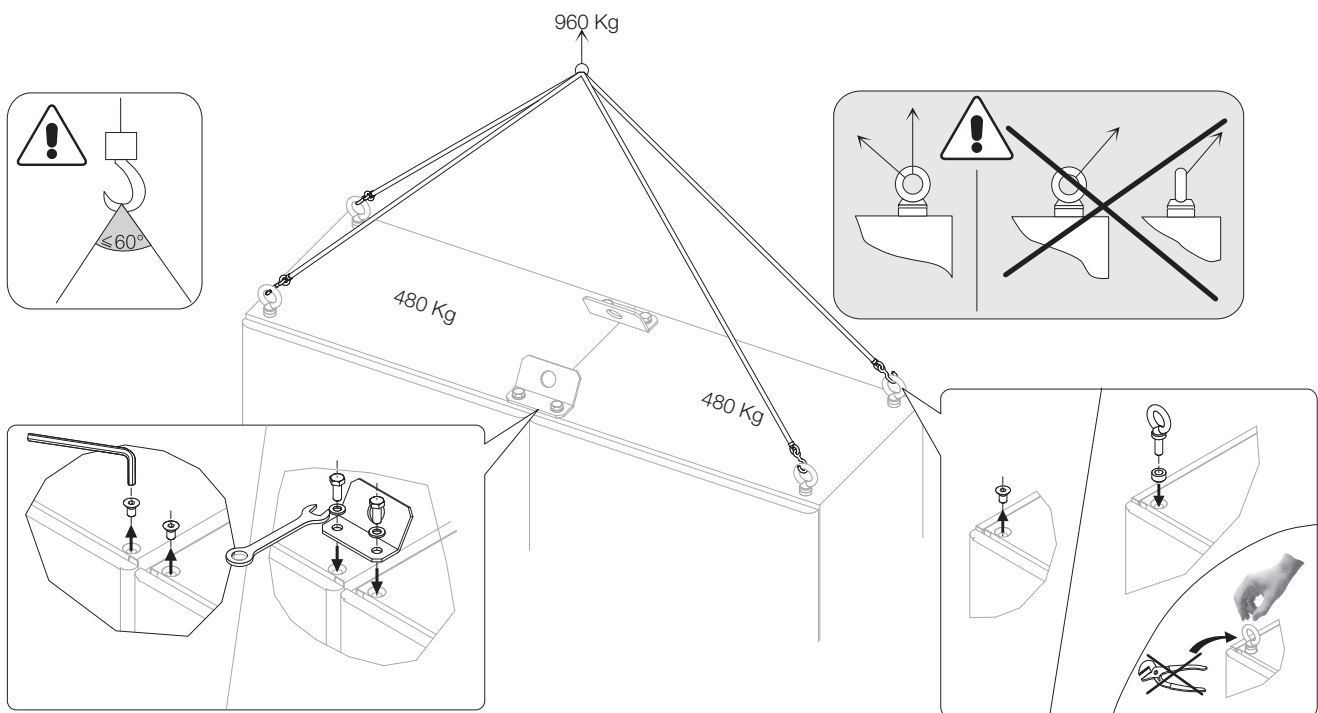

only for 630 A

Enclosure ≥ 800 A:

Due to weight and volume of enclosures lifting beams are requested for handling.

Raw material:

- Polyester powder

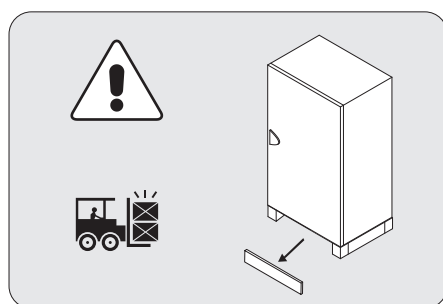
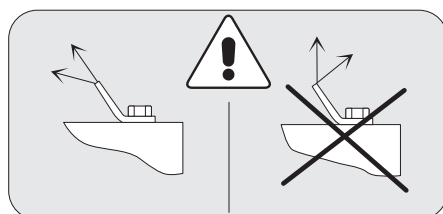
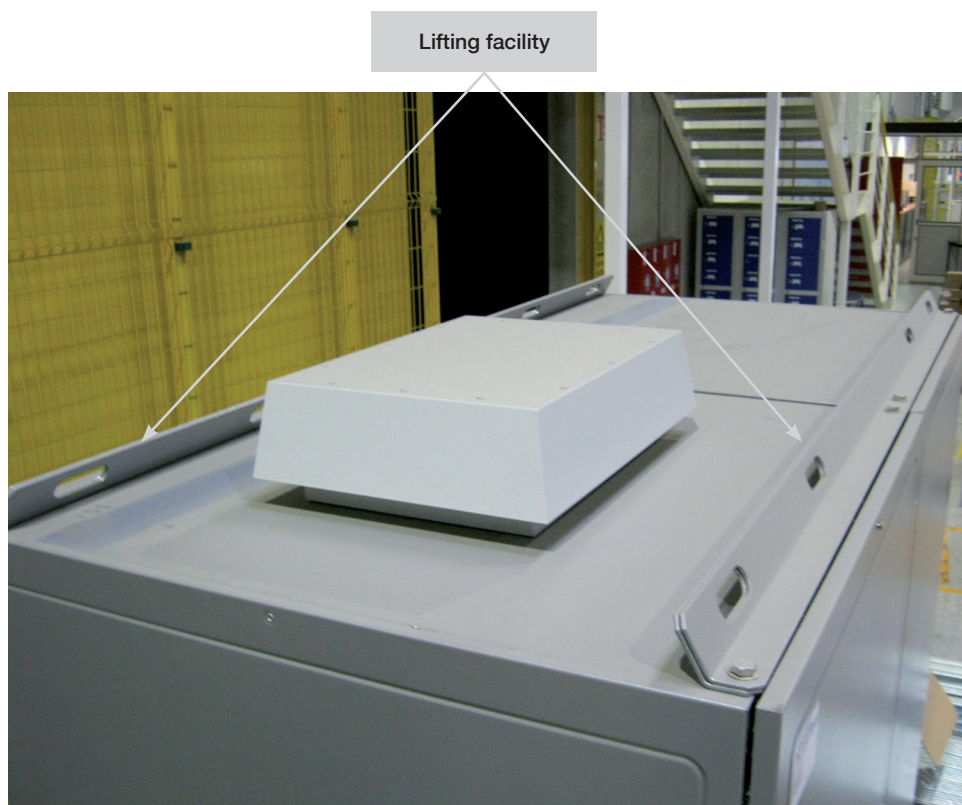

3.2. Equipment fixing

Enclosure ≤ 160 A

The equipment is designed to be wall mounted. 2 fixing busbar are supplied as loose components and should be screwed by the customer. For 125 A enclosure, leave a 40 cm distance on the right side of the enclosure.

Raw material:

- Zinc steel

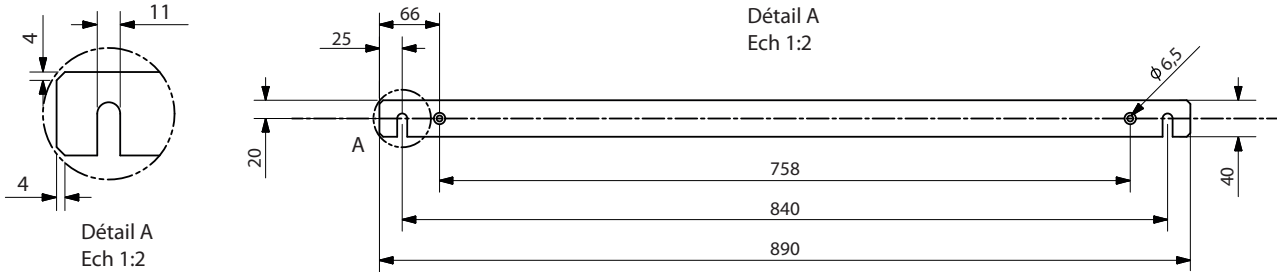

Enclosure 250-400 A

The equipment is designed for floor standing. It is recommended to fix the equipment to the floor using the plinth as per the recommendations below.

For the 250-400 A enclosure, leave a 40 cm distance on the right side of the enclosure.

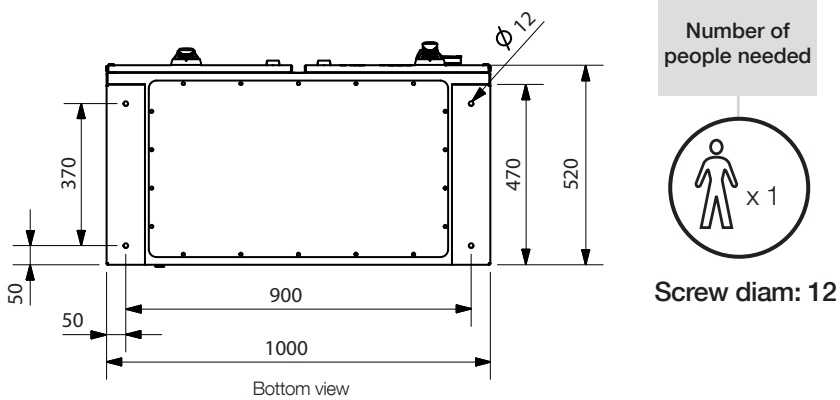

Enclosure ≥ 630 A

The equipment is designed for floor standing. It is recommended to fix the equipment to the floor using the plinth as per the recommendations below.

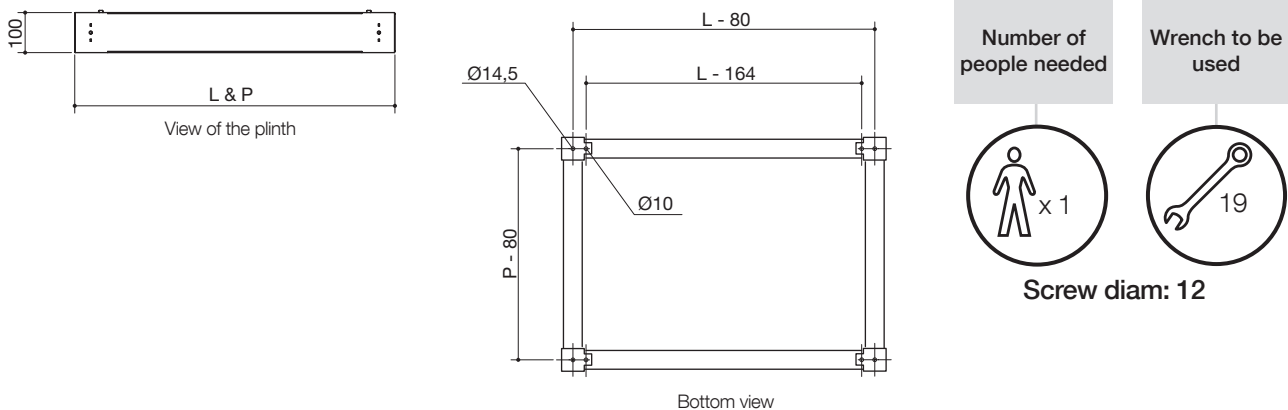

3.3. Connection of control-command circuit / Auxiliary

Enclosure 40- 80 A:

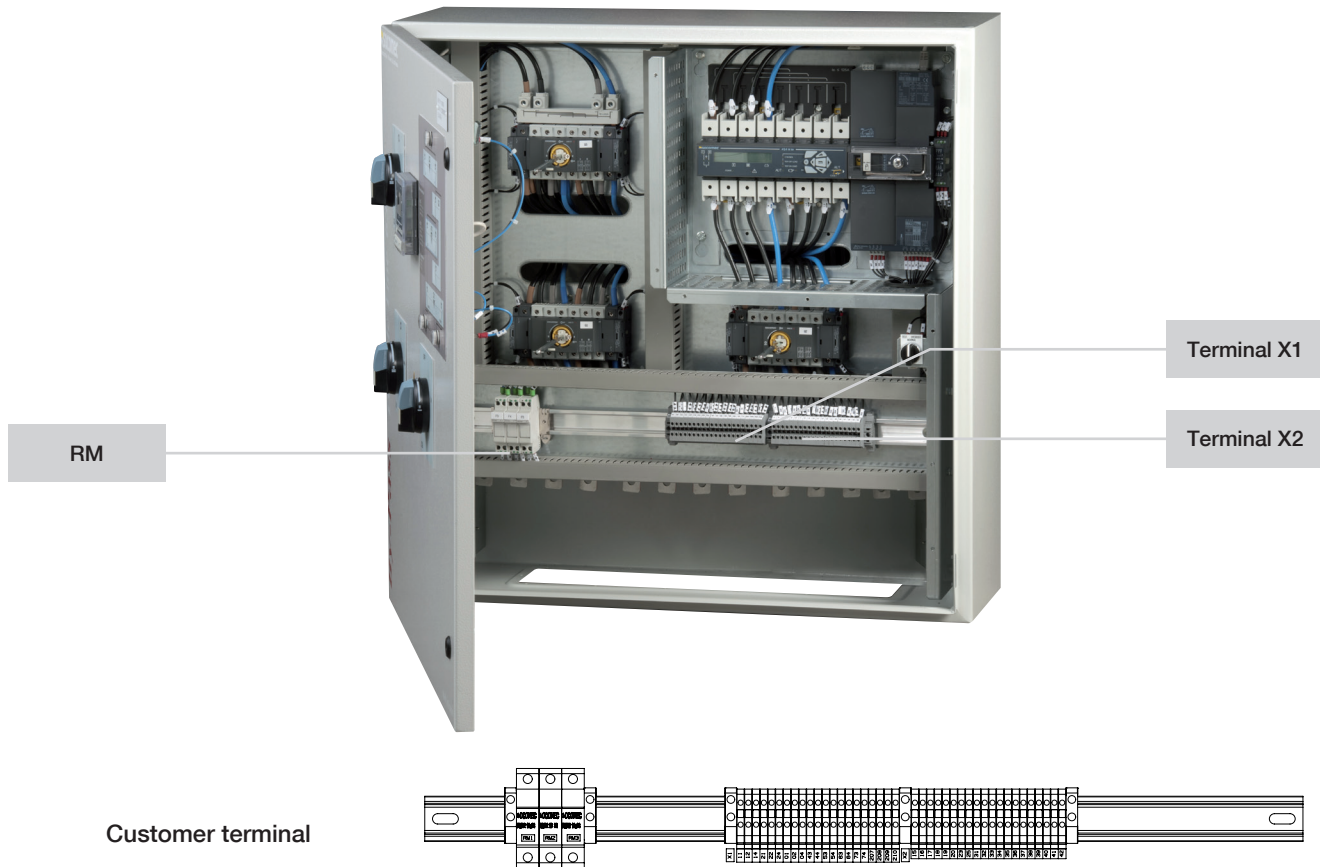

X1

Type	Terminal N°	Description	Characteristics	Connection cross-section
Auxiliary contact block auxiliary	11/12/14	ATS Pos1 Cont Aux	250 VAC, 5 A, AC1	0,5 to 2,5 mm ²
	21/22/24	ATS Pos2 Aux Cont		
	01/02/04	ATS Pos0 Aux Cont		
Outputs	43/44	ATS configurable output	Positive load 2 A 30 VDC 0,5 A 230 VAC	
	53/54	ATS configurable output		
	63/64	ATS configurable output		
	73/74	ATS GE start		
Inputs	207	ATS common point input	Do not connect to any power supply Supply provided	
	208	ATS Configurable Input		
	209	ATS Configurable Input		
	210	ATS Configurable Input		

X2

Type	Terminal N°	Description	Characteristics	Connection cross-section
Auxiliary contact block for Manual Transfer Switch Q1	01/02/03/04	Q1 Bypass Pos AC	250 VAC, 5 A, AC1	0,5 to 2,5 mm ²
	05/06/07/08	Q1 Normal Pos AC		
Auxiliary contact block for Load Break Switch Q2	09/10/11/12	Q2 Pos AC On/Off		
Auxiliary contact block for Manual Transfer Switch Q3	13/14/15/16 17/18/19/20	Q3 P1 Pos AC Q3 P2 Pos AC		



Note: for more information, check the control diagram scheme placed in the enclosure.

Enclosure 100- 125 A:

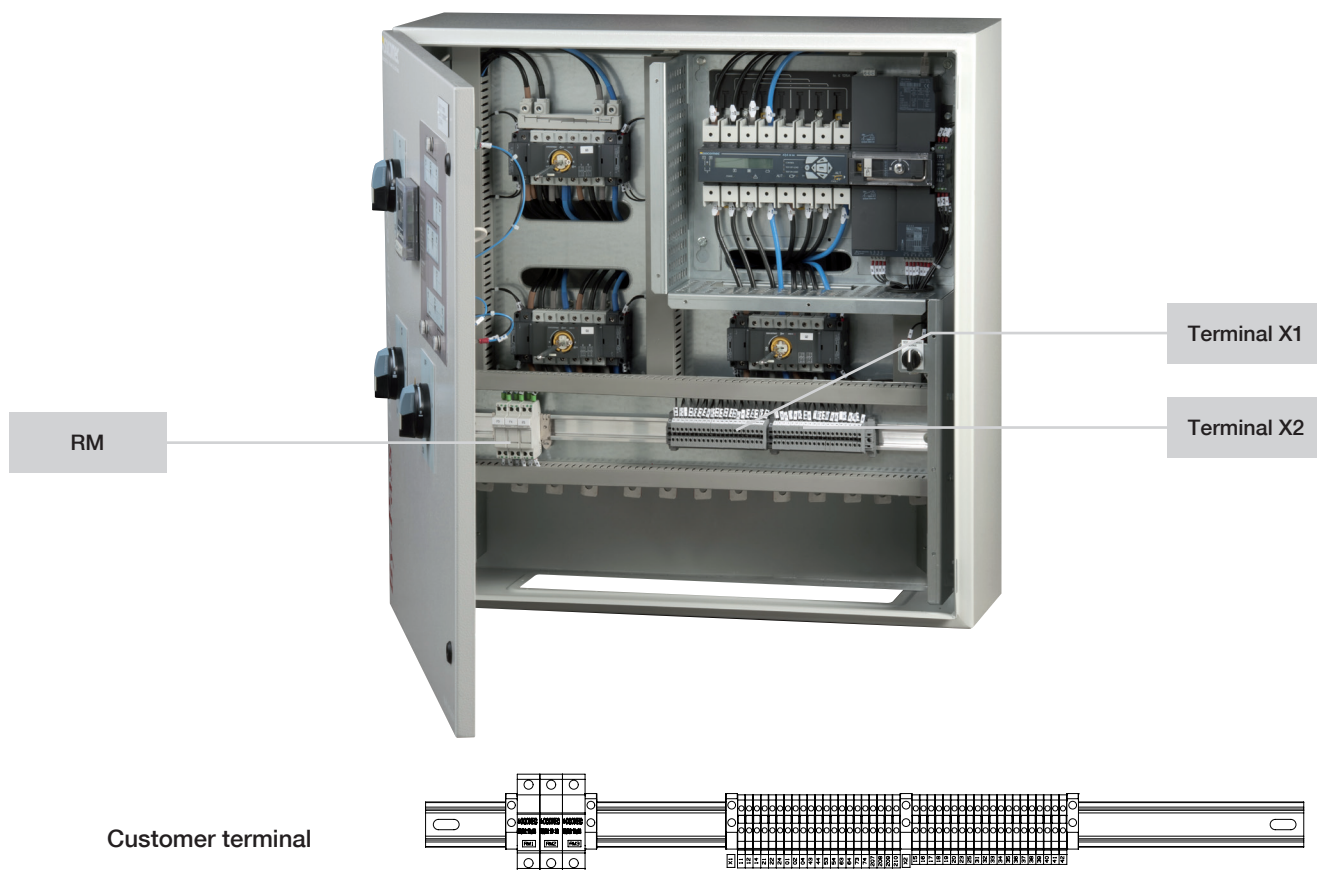

X1

Type	Terminal N°	Description	Characteristics	Connection cross-section
Auxiliary contact block auxiliary	11/12/14	ATS Pos1 Cont Aux	250 VAC, 5 A, AC1	0,5 to 2,5 mm ²
	21/22/24	ATS Pos2 Aux Cont		
	01/02/04	ATS Pos0 Aux Cont		
Outputs	43/44	ATS configurable output	Positive load 2 A 30 VDC 0,5 A 230 VAC	
	53/54	ATS configurable output		
	63/64	ATS configurable output		
	73/74	ATS GE start		
Inputs	207	ATS common point input	Do not connect to any power supply Supply provided	
	208	ATS Configurable Input		
	209	ATS Configurable Input		
	210	ATS Configurable Input		

X2

Type	Terminal N°	Description	Characteristics	Connection cross-section
Auxiliary contact block for Manual Transfer Switch Q1	01/02/03	Q1 Bypass Pos AC	250 VAC, 5 A, AC1	0,5 to 2,5 mm ²
	04/05/06	Q1 Normal Pos AC		
Auxiliary contact block for Manual Transfer Switch Q3	07/08/09 17/18/19/20	Q3 P1 Pos AC Q3 P2 Pos AC		

 Note: for more information, check the control diagram scheme placed in the enclosure.

Enclosure 160-400 A:

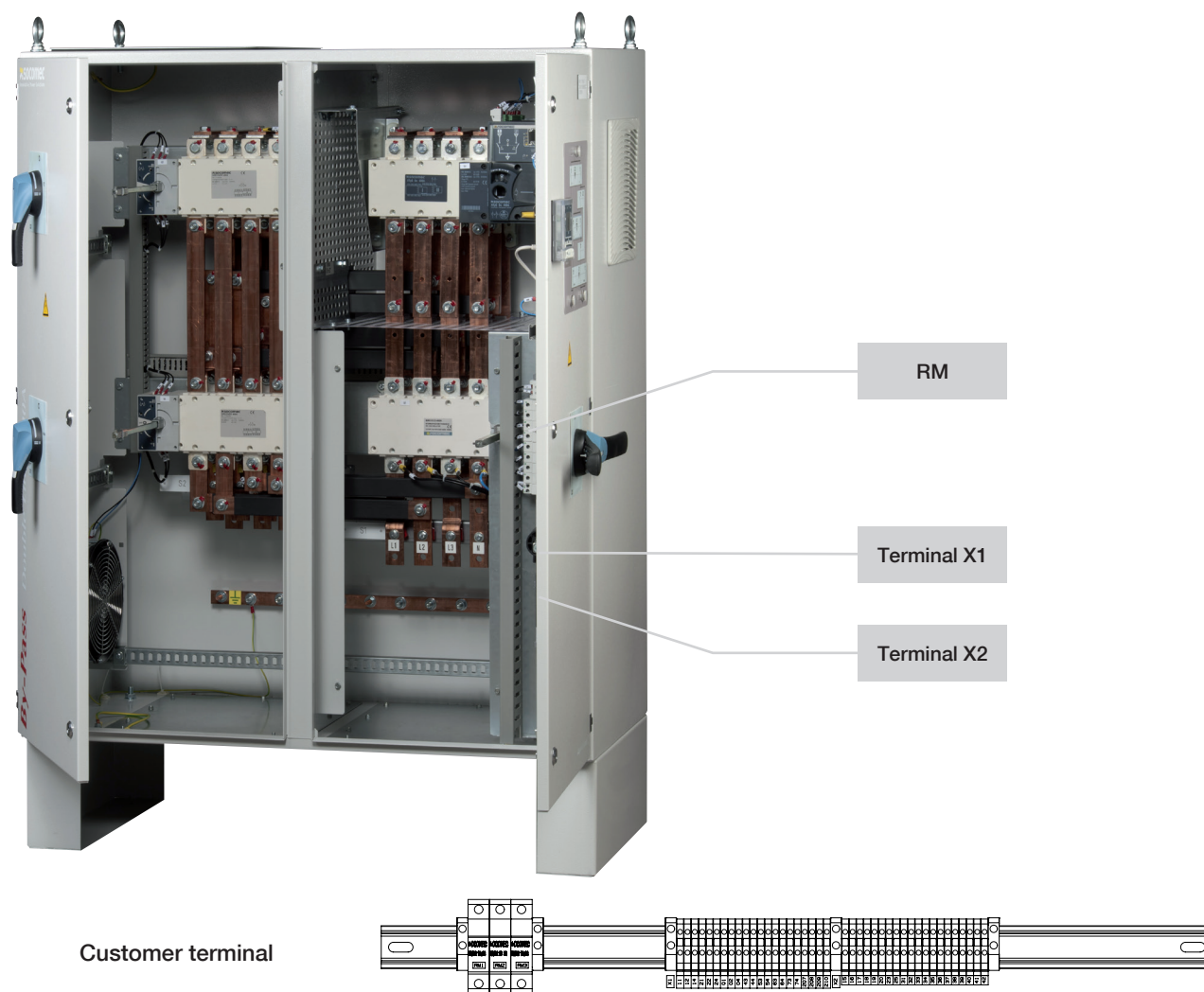

X1

Type	Terminal N°	Description	Characteristics	Connection cross-section
Auxiliary contact block auxiliary	13/14	ATS Pos1 Cont Aux	250 VAC, 5 A, AC1	0,5 to 2,5 mm ²
	13/24	ATS Pos2 Aux Cont		
	13/04	ATS Pos0 Aux Cont		
Availability relay	63A/64A	ATS motor Availability output	250 VAC, 5 A, AC1	
Availability relay	63B/64B	ATS controller Availability output	250 VAC, 5 A, AC1	
GE start/stop	71/72/74	ATS GE start/stop	30 VDC, 5 A, AC1	
Control	207/208/209/210	Input control	Do not connect to any power supply	
Control	312/313/314/ 315/316/317	Input Pos control		

X2

Type	Terminal N°	Description	Characteristics	Connection cross-section
Auxiliary contact block for Manual Transfer Switch Q1	01/02/03	Q1 Bypass Pos AC	250 VAC, 5 A, AC1	-
	04/05/06	Q1 Normal Pos AC		
Auxiliary contact block for Load Break Switch Q2	07/08/09	Q2 Pos AC On/Off		
	10/11/12 13/14/15	Q3 P1 Pos AC Q3 P2 Pos AC		



Note: for more information, check the control diagram scheme placed in the enclosure.

Enclosure 160-400 A:

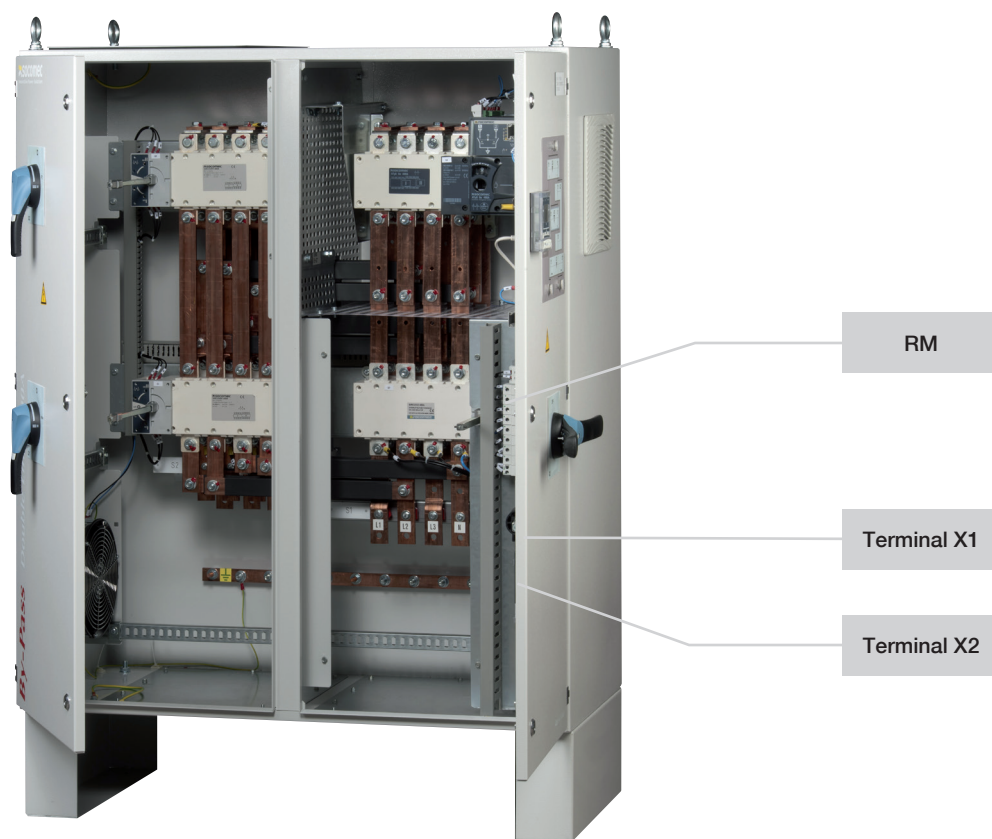

Customer terminal

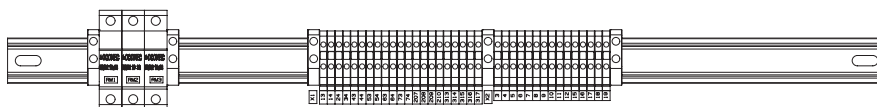

X1

Type	Terminal N°	Description	Characteristics	Connection cross-section
Auxiliary contact block auxiliary	13/14	ATS Pos1 Cont Aux	250 VAC, 5 A, AC1	0,5 to 2,5 mm ²
	13/24	ATS Pos2 Aux Cont		
	13/04	ATS Pos0 Aux Cont		
Availability relay	63A/64A	ATS motor Availability output	250 VAC, 5 A, AC1	
Availability relay	63B/64B	ATS controler Availability output	250 VAC, 5 A, AC1	
GE start/stop	71/72/74	ATS GE start/stop	30 VDC, 5 A, AC1	
Control	207/208/209/210	Input control	Do not connect to any power supply	
Control	312/313/314/ 315/316/317	Input Pos control		

X2

Type	Terminal N°	Description	Characteristics	Connection cross-section
Auxiliary contact block for Manual Transfer Switch Q1	01/02/03	Q1 Bypass Pos AC	250 VAC, 5 A, AC1	
	04/05/06	Q1 Normal Pos AC		
Auxiliary contact block for Load Break Switch Q2	07/08/09	Q2 Pos AC On/Off		
Auxiliary contact block for Manual Transfer Switch Q3	10/11/12	Q3 P1 Pos AC		
	13/14/15	Q3 P2 Pos AC		



Note: for more information, check the control diagram scheme placed in the enclosure.

3.4. Connection of power circuit

On the enclosed ATS By-Pass solution (40 A to 3200 A), customer's connection is as follows:

- 40 to 125 A: Bottom/Bottom; Top/Bottom; Bottom/Top; Top/Top
 - 160 A Bottom/Bottom
 - 250 to 400 A: Bottom/Bottom; Bottom/Top
 - 630 A: Bottom/Bottom (Top/Top or Bottom/Top upon request)
- From 800 A: please consult us.

Enclosure ≤ 160 A:

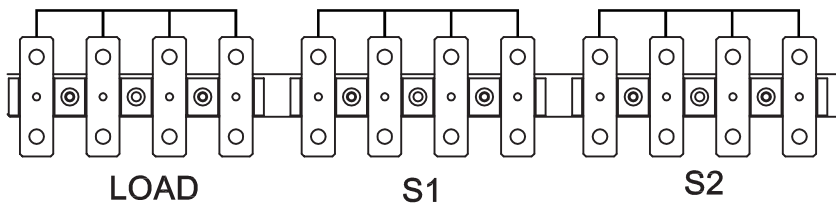
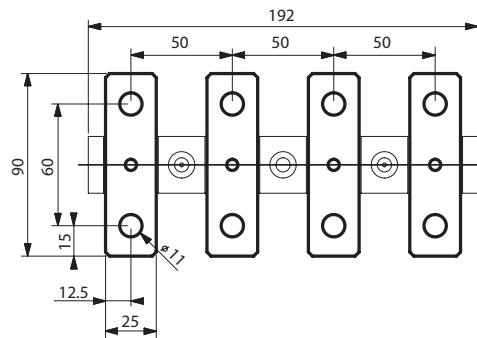

Rating (A)	Recommended connection cross-section (mm ²)
40	10
63	16
80	25
100	35
125	50
160	70



Please follow the recommended tightening torque:
M8: 8,3 N.m
M10: 20 N.m
M12: 40 N.m

 Note: for aluminium cable, kindly contact us..

Enclosure 250-400 A:

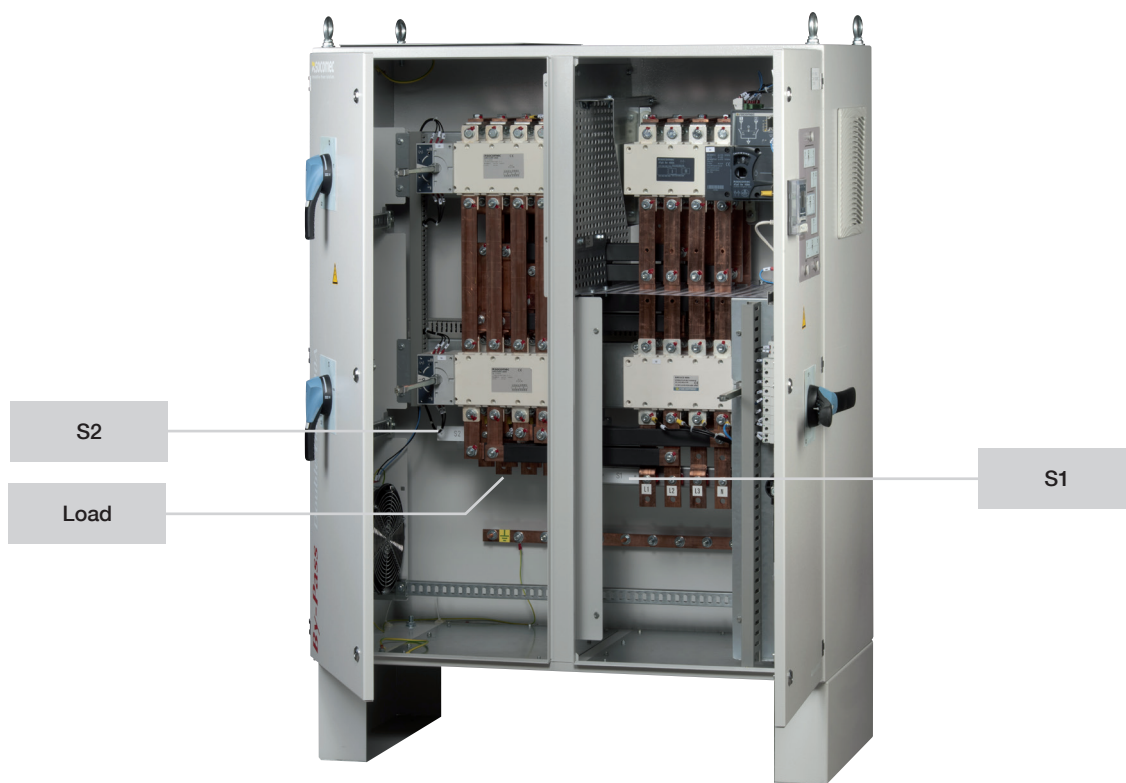

Connection 250 A

Connection 400 A

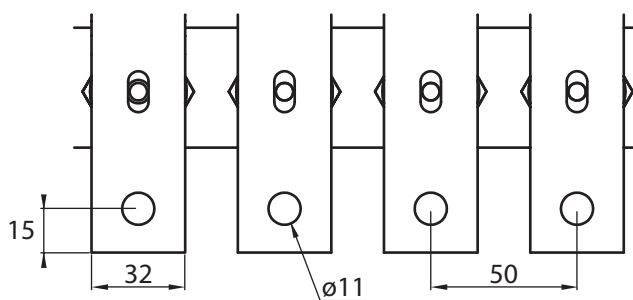
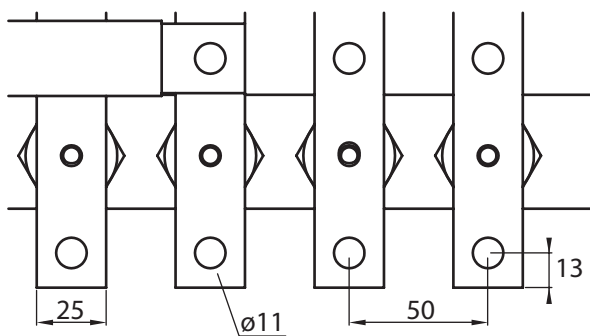

Rating (A)	Recommended connection cross-section (mm ²)
250	120
400	240



Please follow the recommended tightening torque:
M8: 8,3 N.m
M10: 20 N.m

 Note: for aluminium cable, kindly contact us..

Enclosure 630-3200 A:

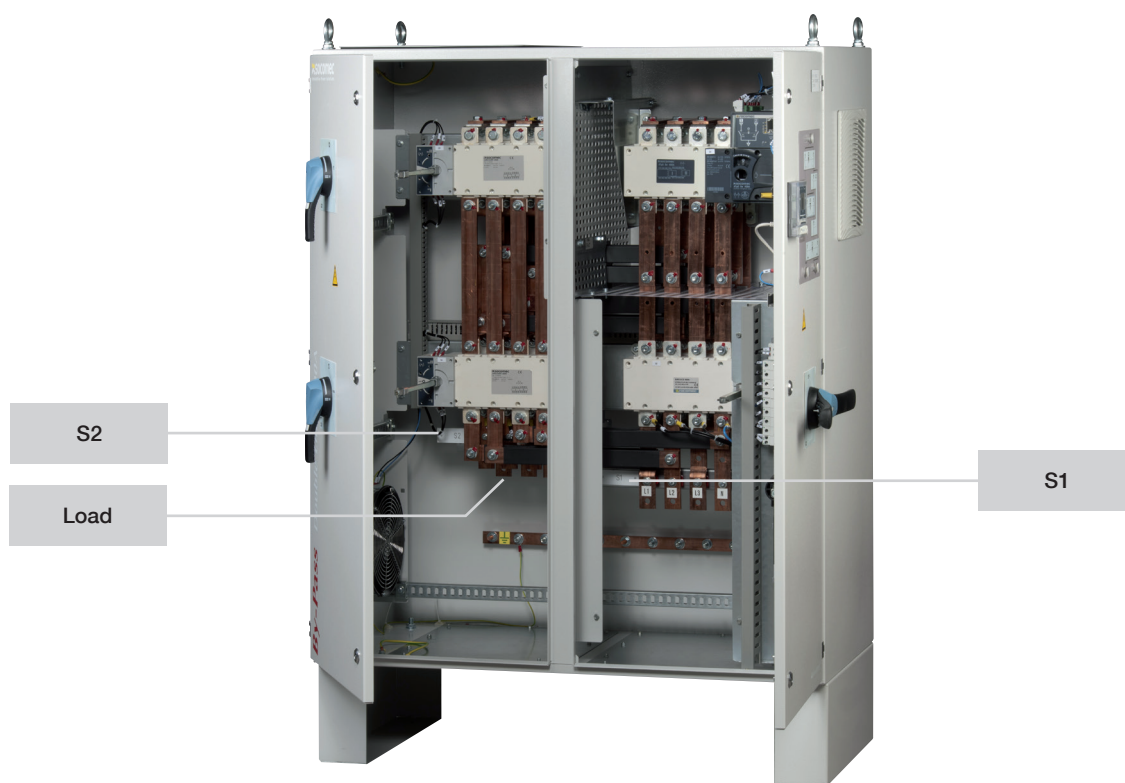

Connection 630 A

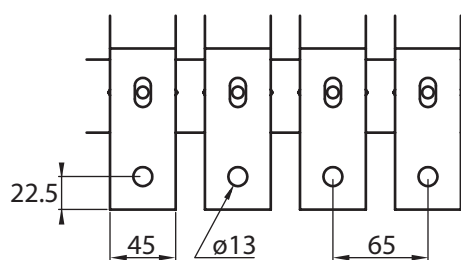

Rating (A)	Recommended connection cross-section (mm ²)
630	2 x 185
800	2 x 240
1000	4 x 150
1250	4 x 185
1600	4 x 240
2000	8 x 150
2500	8 x 185
3200	8 x 240



Please follow the recommended tightening torque:

M10: 20 N.m

M12: 40 N.m



Note: for aluminium cable, kindly contact us..

3.5. Accessories fitting

OPTIONAL I/O MODULE (ONLY ON ENCLOSURES FROM 250 to 3200 A)

Presentation

Some connectors are dedicated to optional modules.

4 slots on the ATyS p range (a communication module RS485 is factory provided, possibility to have up to 2 I/O modules).

The I/O modules can be mounted on any slots, as per the following procedure:

The communication module RS485 is provided by default on slot 1:

- 2nd option on slot 2,
- 3rd option on slot 3,
- 4th slot not used.

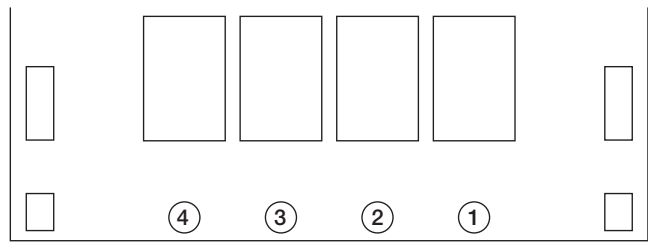

Installation



Turn power off before connecting the module

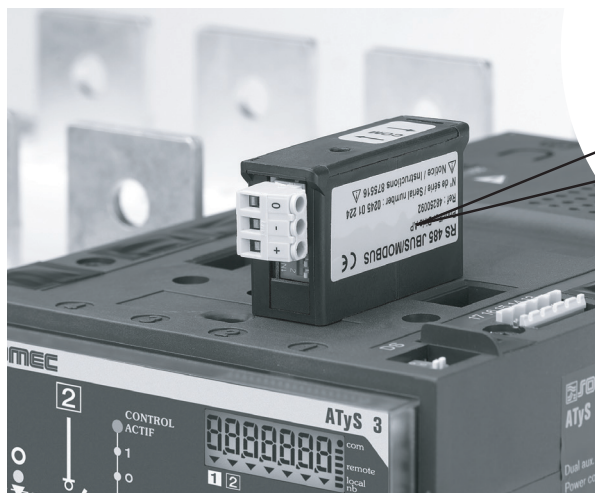

A 3 minutes power off action is necessary to allow module recognition.

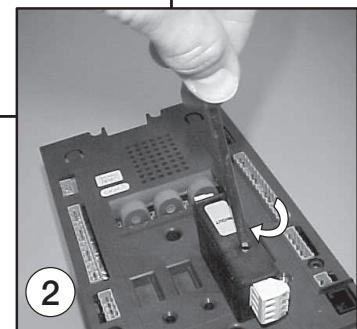
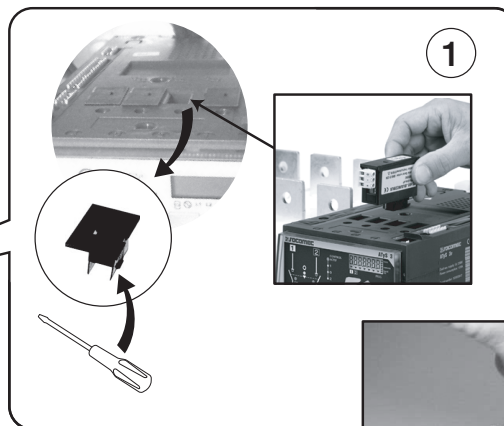
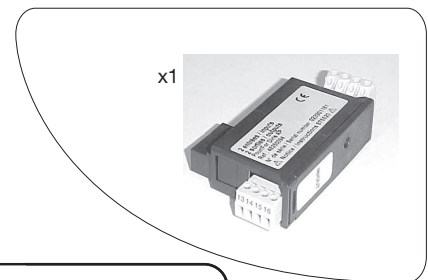

Inputs/outputs identification

Up to four inputs/outputs can be used if two optional I/O modules are available.

Terminal identification depends on modules location. 2I/2O terminal identification is chronological from the first module, without taking into account the communication module.

Example: identification In1 to In 4 and Ou1 to Ou4

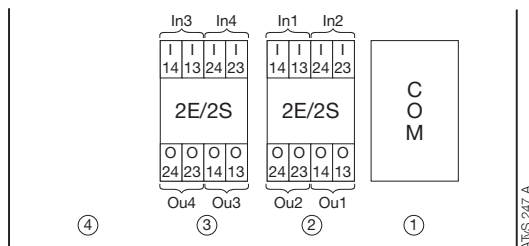

3.6. Programming

The equipment is delivered with factory settings on the ATS.

Those values have to be modified and validated as per installation parameters.

3.6.1. ATyS p M (≤ 125A)

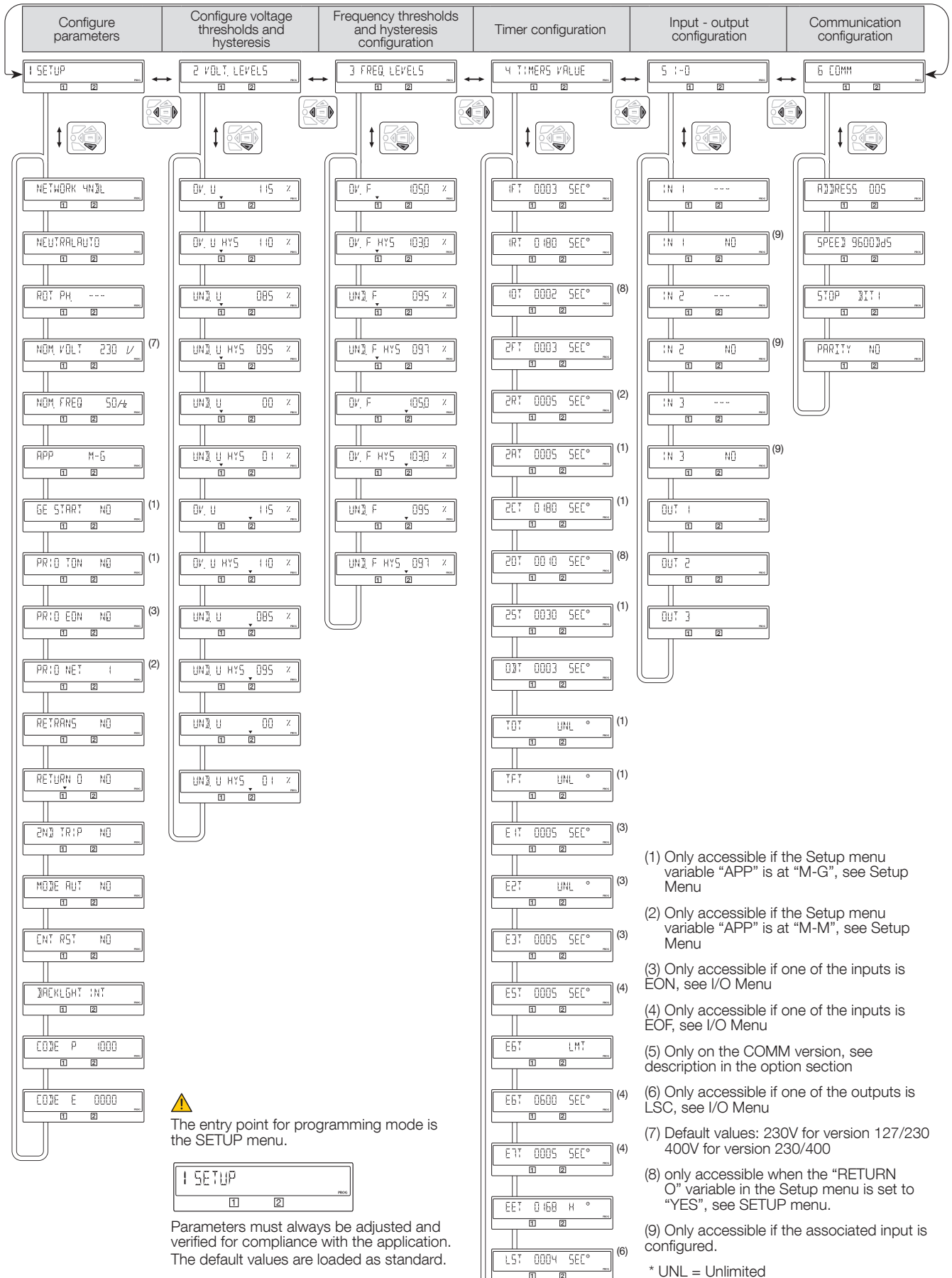

To access programming
Default code: 1000

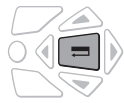
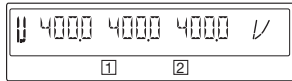

Press for 3 s

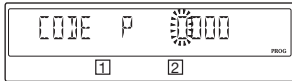

To modify
the value
of this digit

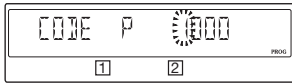

To access
the other
digits

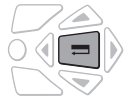
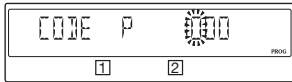

Validate
entry

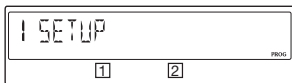

Browsing

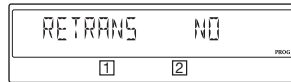
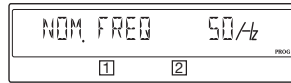
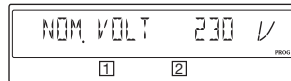
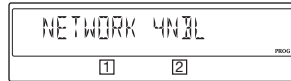
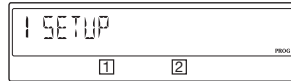

Exit programming



Press the
validate button
for 3 seconds.

The LED signalling is only active when the product supply is on (supply LED lit)

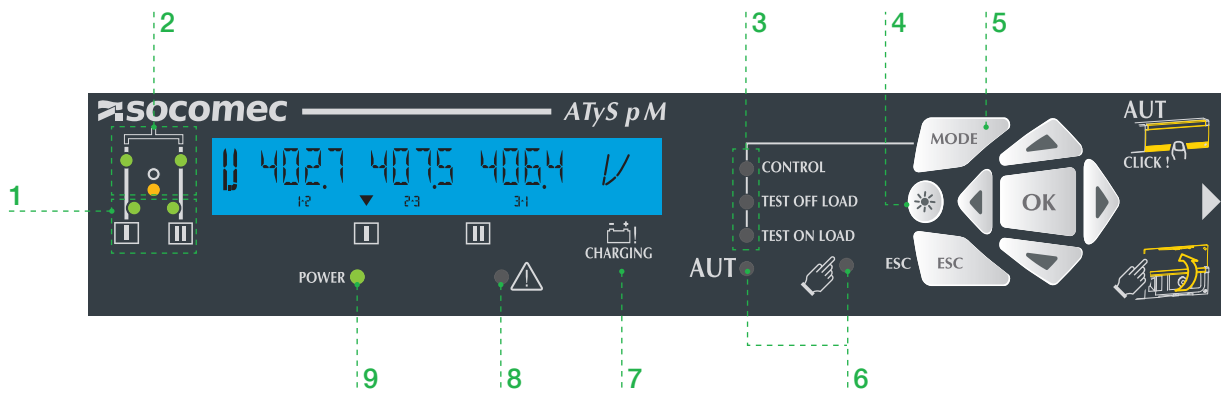

1. Availability of sources

- 2 green LEDs to indicate whether source I and/ or source II are available (voltages and frequencies check).
 - LED lit = source available.
 - LED off = source unavailable.

2. Position of the switch

- 2 green LEDs
 - LED I lit = switch in position I
 - LED II lit = switch in position II
- 1 yellow LED
 - LED lit = switch in position 0

3. Test/Control modes

- 2 yellow LEDs for the test on load and test off load which are linked to the test mode selection button so as to facilitate selection.
- 1 yellow LED for the control function. The user may force the position of the switch.

4. LED test button

-  : Illuminates all LEDs to test their operation.

5. Mode button

- Test mode selection button.

6. Operating mode (Auto/Manu)

-  : 1 yellow LED for MANU mode active.
- AUT : 1 green LED for AUTO mode active.

7. Capacitor charge indicator

- Return to zero capacitor charge. When the indicator flashes, the RETURN to 0 function is unavailable.

8. Fault LED

- 1 red LED to indicate the status of the product control fault. Open and close the AUT/MANU cover after clearing the fault.

9. Power supply LED

- 1 green LED
 - Always off: power supply off or software error if the other indicators are operational (LED and Screen).
 - Always lit: product power supply on.

3.6.2. Test modes

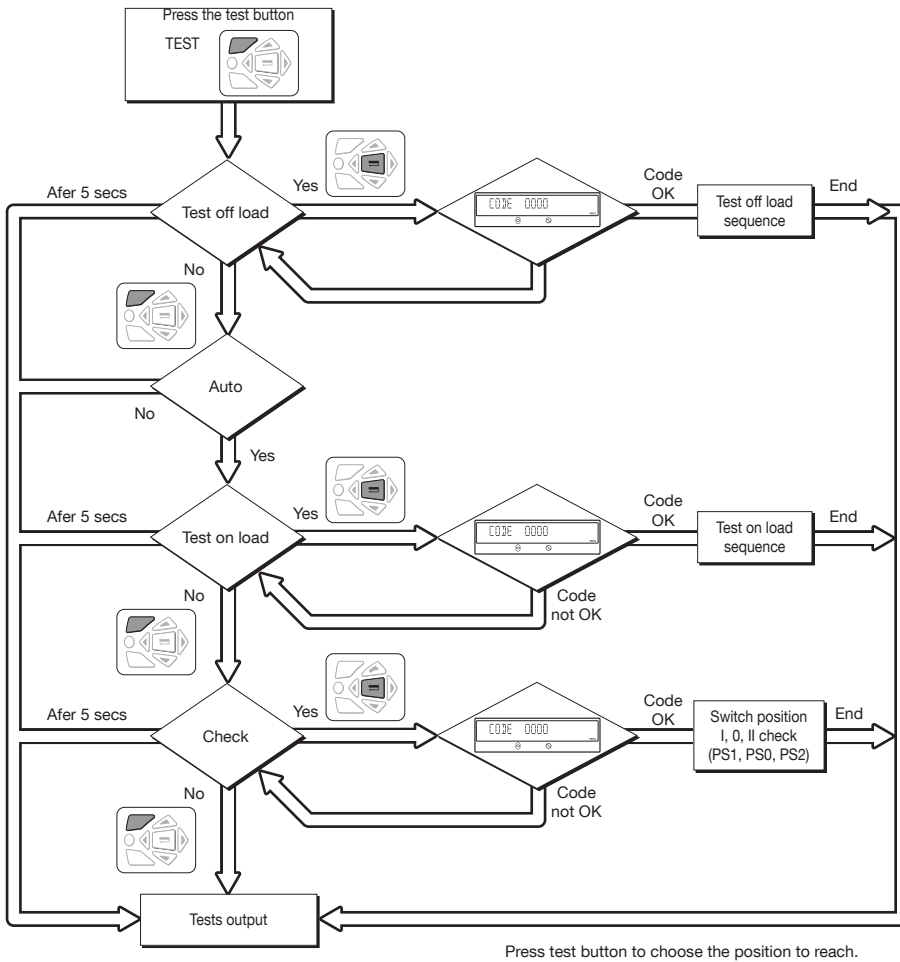

3.6.3. ATyS p (>125 A)

Programming the ATyS p

The ATyS p is to be programmed powered up and after wiring verification tests. This may either be done through the front of the ATS Controller using the keypad or with the user-friendly Easy Config software.

For convenience, we recommend to use the Easy Config software. (Downloadable free from www.socomec.com).

The ATyS p is delivered with default setting values based on most used customer application requirements. The minimum configuration parameters that must be programmed are the type of network and application together with the voltage and frequency nominal values. ATyS p Auto Configuration makes the setup of Volts, Hz, Phase rotation and Neutral Position quick and easy.

A - Programming with Easy Config Software

To program the ATyS p using Easy Config software simply follow the setting boxes from left to right until all desired settings in each window have been completed. Help pop ups are included to show the minimum and maximum setting values allowed. The software includes most SOCOMEC products so before programming click NEW and select the product "ATyS p" from the list of products available.

When the ATyS p is powered and communicating, the software will include a screen to monitor and display the ATyS p status.

Control through software (such as changing).

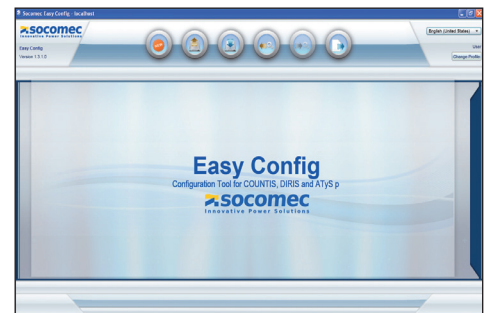

B - Programming with the ATyS p keypad

1	SETUP	2	VOLT. LEVELS	3	FREQ. LEVELS	4	PWR. LEVELS	5	TIMERS VALUE	6	I-O	7	COMM	8	DATE/TIME
NETWORK	4NBL	OV. U	I 115%	OV. F	I 105%	OV.P	I 0000 kVA	1FT	0003 SEC	IN 1	--- NO	DHCP	NO (9)	YEAR	
AUTOCONF	NO (7)	OV. U HYS	I 110%	OV. F HYS	I 103%	OV.P HYS	I 0000 kVA	1RT	0180 SEC	IN 2	--- NO	IP 1-2	192.168.	(9) MONTH	
NEUTRAL	AUTO	UND. U	I 085%	UND. F	I 095%	OV.P	II 0000 kVA	2FT	0003 SEC	IN 3	--- NO	IP 3-4	.002.001	(9) DAY	
ROT PH.	---	UND. U HYS	I 095%	UND. F HYS	I 097%	OV.P HYS	II 0000 kVA	2RT	0005 SEC (2)	IN 4	--- NO	GAT1-2	000.000.	(9) HOUR	
NOM. VOLT	400 V	UNB. U	I 00%	OV. F	II 105%	(1) When «APP» is set to «M-G»		2AT	0005 SEC (1)	IN 5	--- NO	GAT3-4	.000.000	(9) MINUTE	
NOM. FREQ	50 Hz	UNB. U HYS	I 00%	OV. F HYS	II 103%	(2) When «APP» is set to «M-M»		2CT	0180 SEC (1)	IN 6	--- NO	MSK1-2	255.255.	(9) SECOND	
APP	M-G	OV. U	II 115%	UND. F	II 095%	(3) When one of the I/P is set to «EON»		2ST	0030 SEC (1)	IN 7	--- NO (8)	MSK3-4	.255.000	(9)	
PRIO TON	NO (1)	OV. U HYS	II 110%	UND. F HYS	II 097%	(4) When one of the O/P is set to «LSC»		ODT	0003 SEC	IN 8	--- NO (8)	ADDRESS	005		
PRIO EON	NO (3)	UND. U	II 085%			(5) When one of the O/P is set to «EES»		TOT	UNL (1)	IN 9	--- NO (8)	BDRATE	9600		
PRIO NET	1 (2)	UND. U HYS	II 095%			(6) If the product is in manual mode		TOT	0010 SEC (1)	IN10	--- NO (8)	STOP BIT	1		
RETRANS	NO	UNB. U	II 00%			(7) With optional I/O modules		T3T	0000 SEC (1)	IN11	--- NO (8)	PARITY	NONE		
CT PRI	100	UNB. U HYS	II 00%			(8) With Ethernet module		TFT	UNL (1)	IN12	--- NO (8)				
CT SEC	5							TFT	0600 SEC (1)	IN13	--- NO (8)				
S1=SW2	NO							E1T	0005 SEC (3)	IN14	--- NO (8)				
BACKLGH	INT							E2T	UNL (3)	OUT 1	POP NO				
CODE P	1000							E2T	0010 SEC (3)	OUT 2	--- NO (8)				
CODE E	0000							E3T	0005 SEC (3)	OUT 3	--- NO (8)				
BACKUP	SAVE							E5T	0005 SEC (4)	OUT 4	--- NO (8)				
								E6T	LIM (4)	OUT 5	--- NO (8)				
								E6T	0600 SEC (4)	OUT 6	--- NO (8)				
								E7T	0005 SEC (4)	OUT 7	--- NO (8)				
								LST	0004 SEC (5)	OUT 8	--- NO (8)				
								EET	0168 H (6)	OUT 9	--- NO (8)				
								EDT	1800 SEC (6)						

ATyS p devices may also be programmed through the ATS controller keypad. This programming method is necessary for products not equipped with Ethernet or Modbus communication modules that facilitate programming through Easy Config software described above. The keypad is a useful interface and programming method most especially when changing a few parameters or simply interrogating the product.

Programming access: Press and hold for 5 s "Validation" push button (17). Access through the keypad is possible in Automatic or Manual mode, when the product is in a stable position (I, O or II) with at least one supply source available. Programming is not accessible whilst any cycle sequence is running.

To change the configuration: Enter code (factory code = 1000) using navigation push buttons (14).

Programming exit: Press and hold for 5 s "Validation" push button (17).

- Note 1:** Values as listed above are the setting values by default.
- Note 2:** Ensure that the Default Network Setting and Application match the installation or change accordingly before using Auto Configuration.

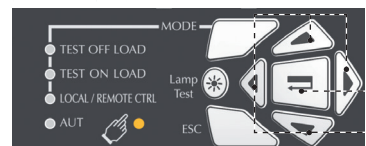
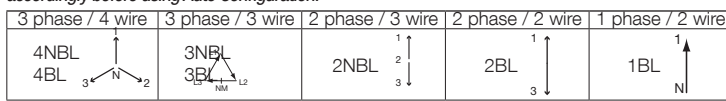

Setup by Auto Configuration
(Volts, Hz, Neutral pos., Ph rotation)

Press 5s	
Go to	1 SETUP
Scroll to	AUTOCONF
Enter code	1000
Set to	YES
Press 60 ms	
LEDs flash	
Save : press 5s	

Note: Source I or source II must be available to set by Auto Configuration.

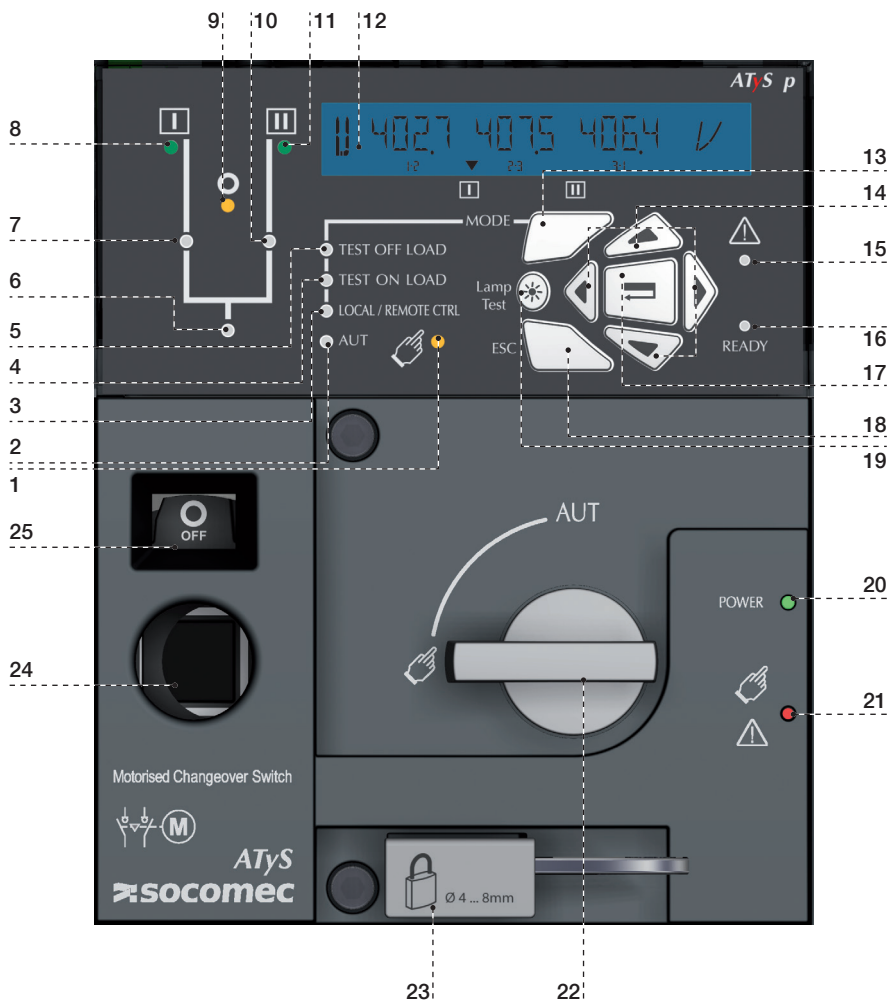

1. MANUAL Mode LED indication. (Yellow steady light when in Manual Mode).
2. AUTO Mode LED indication Green steady light when in Auto mode with no timers running. Green flashing light when in Auto with timers running.
3. LOCAL / REMOTE CONTROL Mode LED indication. Yellow steady light when in Local / Remote control mode. Remote control mode is achieved with the Auto/Manu selector switched to Auto and terminals 312 closed with terminal 317. Remote control orders are received through closing 314 to 316 with 317. REMOTE Control is also achievable through Easy Config ATyS p software when connected to the product through Ethernet or MODBUS. (Optional modules). Local Control selectable and operable through the ATyS p keypad.
4. TEST ON LOAD CONTROL Mode LED indication. (Yellow steady light when in TON/EON mode)
5. TEST OFF LOAD CONTROL Mode LED indication. (Yellow steady light when in TOF/EOF mode).
6. Load Supply On LED. (Green when the load is supplied).
7. Switch 1 LED position indication. (Green when in position 1).
8. Source supply I availability LED indication. (Green when supply I voltage is within the set limits).
9. Zero position LED indication. (Yellow when in position 0).
10. Switch 2 LED position indication. (Green when in position 2).
11. Source supply II availability LED indication. (Green when supply II voltage is within the set limits).
12. LCD Display Screen : (Status, measurement, timers, counters, events, faults, programming)
13. MODE key to shift between operation modes.
14. Navigation Keys to browse through the ATyS p menus without software.
15. FAULT LED Indication. (Red steady light in case of an ATS controller internal fault. Switch the product from Auto to Manual and back to Auto to reset a fault condition).
16. READY LED indication. (Green steady light : Product is powered and in AUTO, Watchdog OK, The Product is Available to changeover).
17. Enter Key used to enter Prog Mode (Press and hold for 5 seconds) and to validate the settings programmed through the keypad.
18. ESC key used to escape from a specific screen up to the main menu.
19. Lamp test key to check the LED's and LCD screen.
20. Green LED Indication: Power
21. Red LED Indication: Product Unavailable / Manual Mode / Fault Condition
22. Auto / Manual mode selector switch (Key version available as an option)
23. Padlocking facility (Up to 3 padlocks of dia. 4 - 8mm)
24. Emergency manual operation shaft location (Accessible only in manual mode)
25. Switch position indication window: I (On switch I) O (Off) II (On switch II).

Programming mode allows product parameter configuration through the keypad:

- It is always accessible when the product is in Manual position
- It is always accessible in AUT with the load on the priority source and priority source available.

The minimum configuration parameters that must be programmed before use are:

- type of network
- nominal voltage
- nominal frequency.

Navigation in the programming menu



- To enter the programming menu press and hold the validation key until “SETUP” appears on the screen.



or



- For parameter access: Press the “up – down” or “left – right” keys to navigate.

Programming



- Navigate to the parameter to be changed and press the validation key.

Note: The product will request a password.



+



- Input the password by using the “up – down” keys to change the value and the “left – right” keys to change the cursor position. (The default factory setting is 1000).

- Press the validation key to validate the password and enable programming.

+



- Change the parameter value by using the “up – down” keys to change the variable and the “left – right” keys to change the cursor position.

+



- Press the validation key to validate the change.

- If necessary, navigate to other parameters in the menu, change the value and validate each change.

+



- To save all changes, press and hold the validation key until “SAVED” is displayed.

Note: After saving, “SAVED” will be displayed for 2s, the product will automatically exit programming mode and will then return to the main menu.

Exiting programming mode without saving



- To quit programming mode without saving briefly press the “ESC” key. This will allow navigating back to the main menu.

Note: Whilst in programming mode, should the product remain idle for longer than 2 minutes it will automatically exit and return to the main menu without saving.

Example:

To modify network nominal voltage from 400 to 230 V.

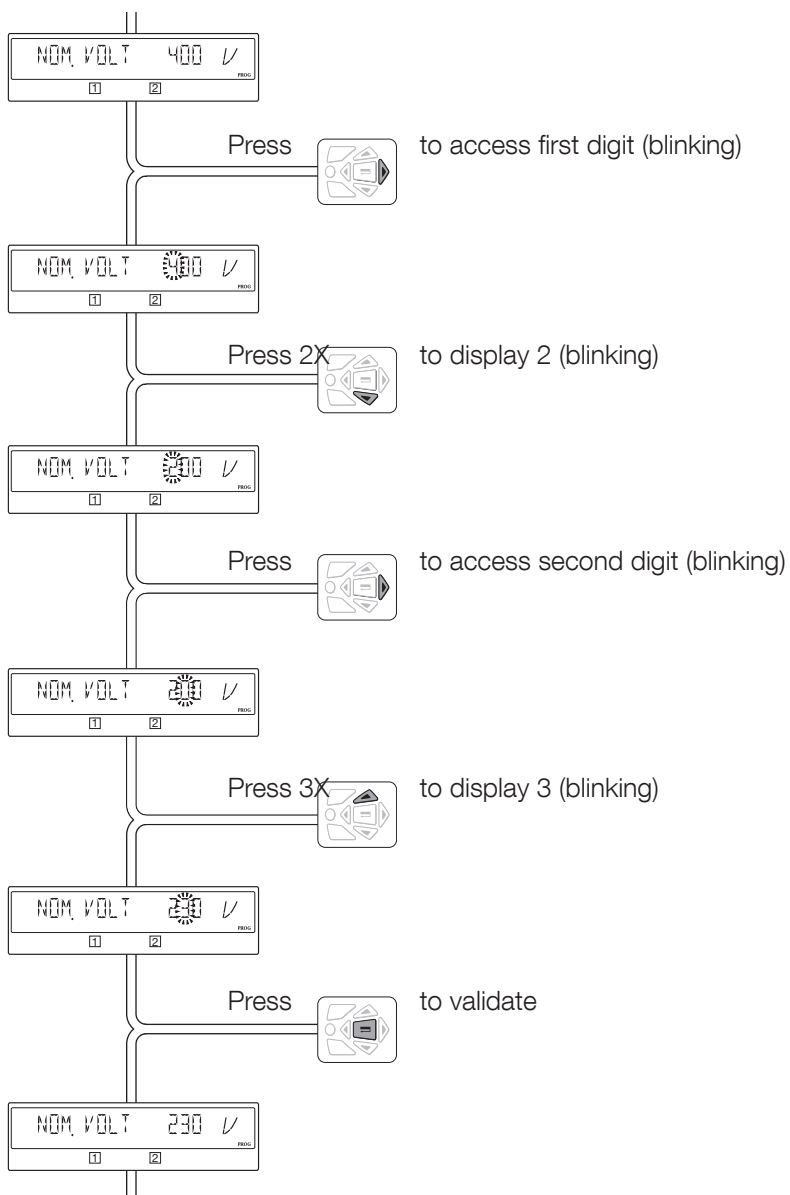

The ATyS p includes for On-Load as well as Off Loads tests that are always associated with Mains – Gen applications. To operate the tests manually through the keypad the following flow diagram shows the different steps.

Tests as well as Engine Exerciser cycles are also easily programmed and triggered when using the ATyS Webserver and the Easy-Config software. Webserver and software will require the Ethernet option installed.

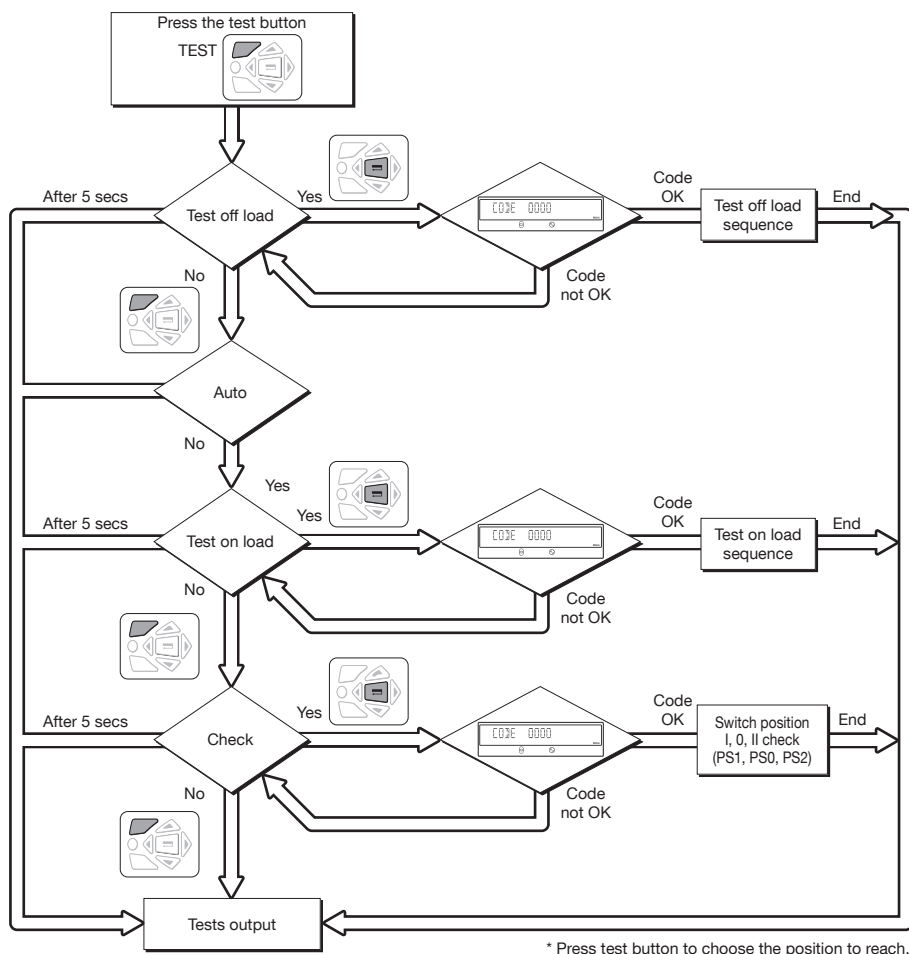

3.6.4. Programming D20

> Enter into programming mode



- Step 1: Press 5 s "validation": PROG led becomes steady

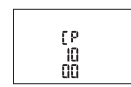

- Step 2: Enter access code (1000 factory default) using the keypad "left", "right", "up" and "down"



- Step 3: Press the "validation" push button

> Navigation in programming mode



- Step 1: To access the required menu, press the "right" and "left" navigation buttons



- Step 2: To access the parameter to be modified, press the "up" and "down" navigation buttons



- Step 3: To modify the parameter, press the "right" navigation button to make the parameter to be modified flash



- Step 4: Press the "up" and "down" buttons to increase or decrease the parameter values



- Step 5: Press "validation" push button to validate



If the parameter to be modified is displayed on 2 lines, press "validate" after modifying the first line to reach the next line



Allows to return to the main menu or to cancel the modification

> Programming mode exit



- Step 1: Press the "ESC" push button when not entering any value, to return to the main programming menu



- Step 2: Press on "ESC" push button again to exit programming

New Active mode (Automatic or Manual) depends on the information from the master ATyS device.

3.6.4.1. Programming example





Load shedding configuration: LS

LS variable allows programming the timer associated shedding.

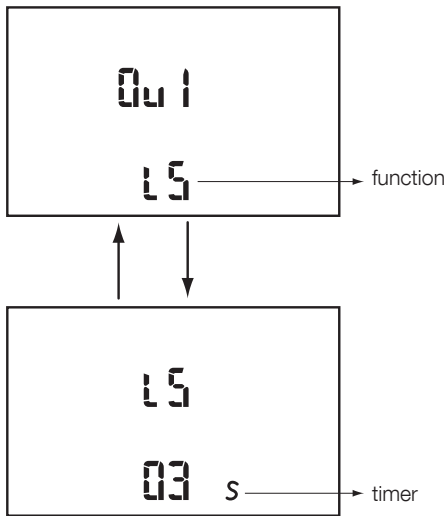
Output	Function	Setting range	Default values
01 to n	LS	0 to 60 s (\leq DTT)*	2

* In case the DTT variable configuration value is below the LS, value LS will be automatically set to the DTT value.



- 
 • Step 1: Press "right" push button to make the first variable blink
- 

 • Step 2: press "up" and "down" to modify the variable
- 
 • Step 3: Press "validate" to validate the variable
- 
 • Step 4: Press "down" to access the nO selection

3.6.4.2. Architecture of the programming menu ATyS D20

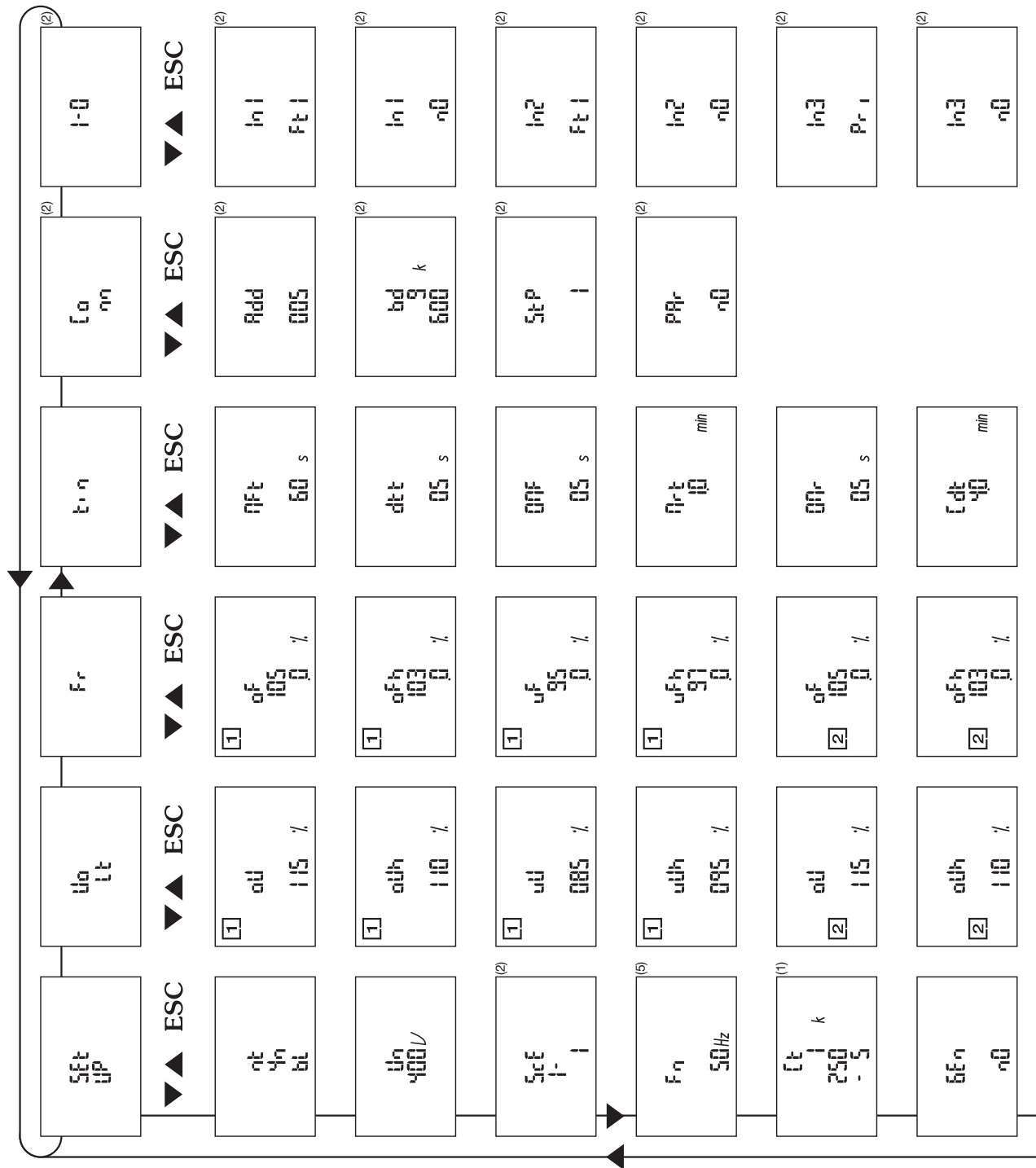
Architecture valid for ATyS p

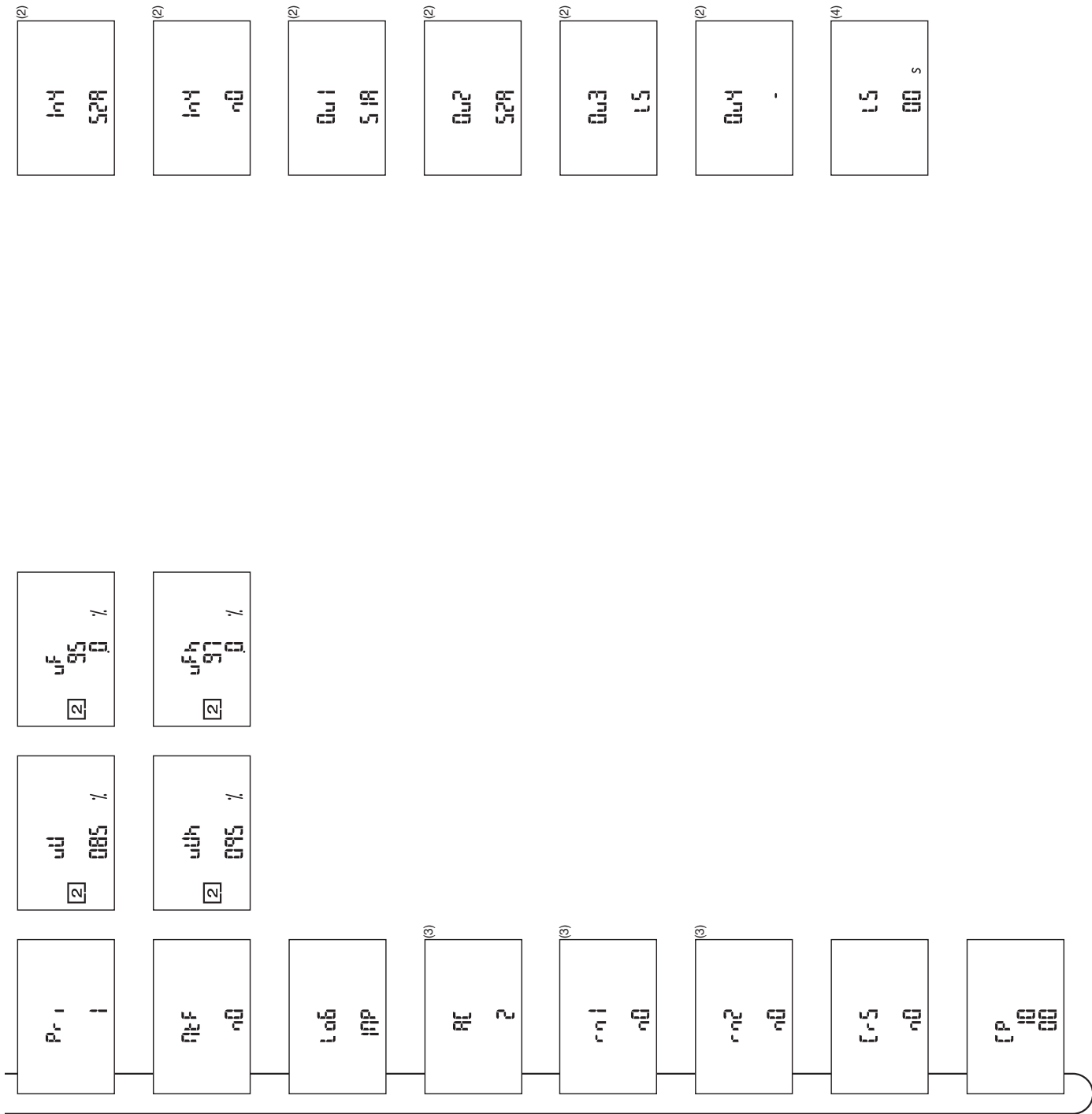

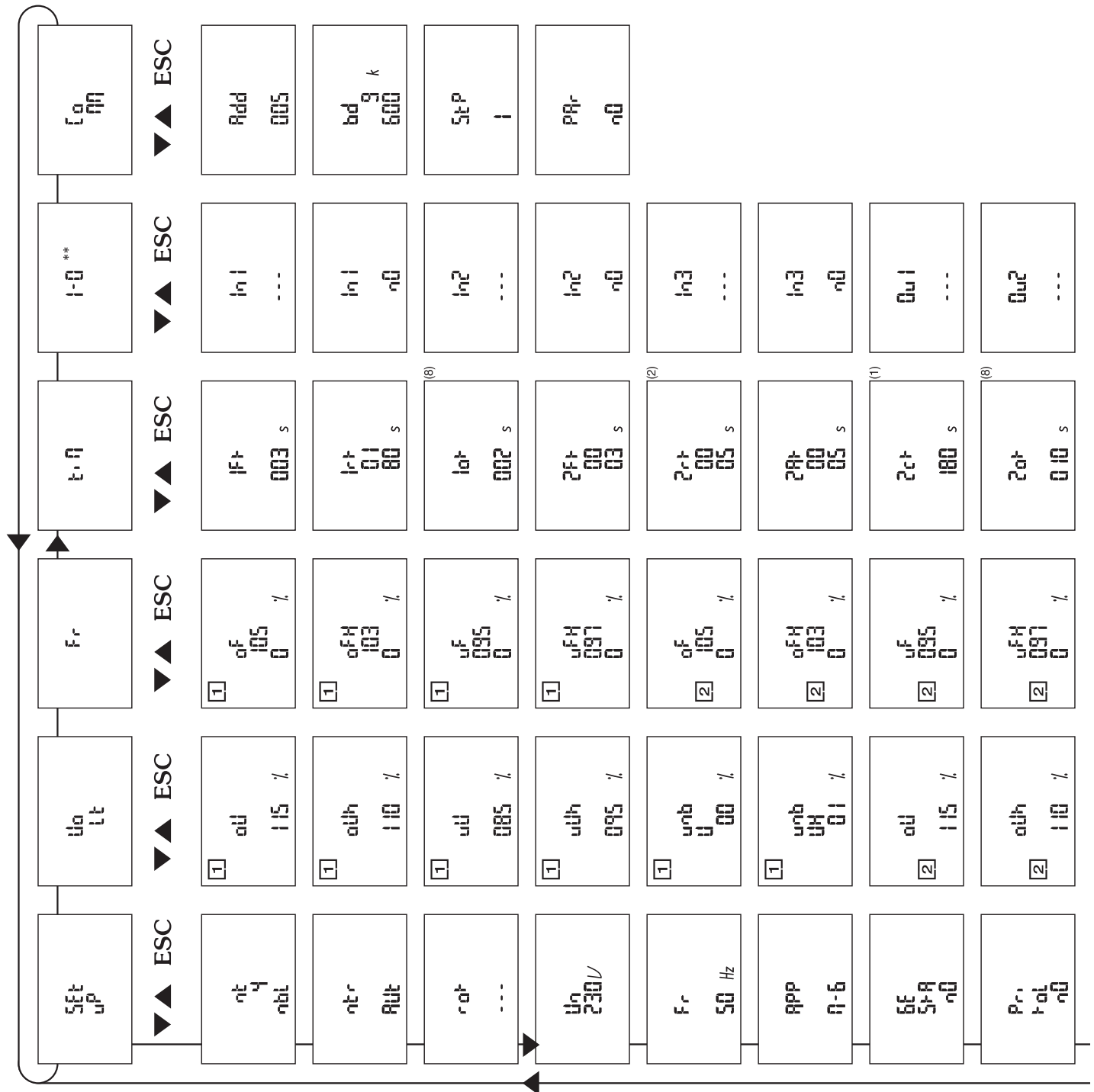



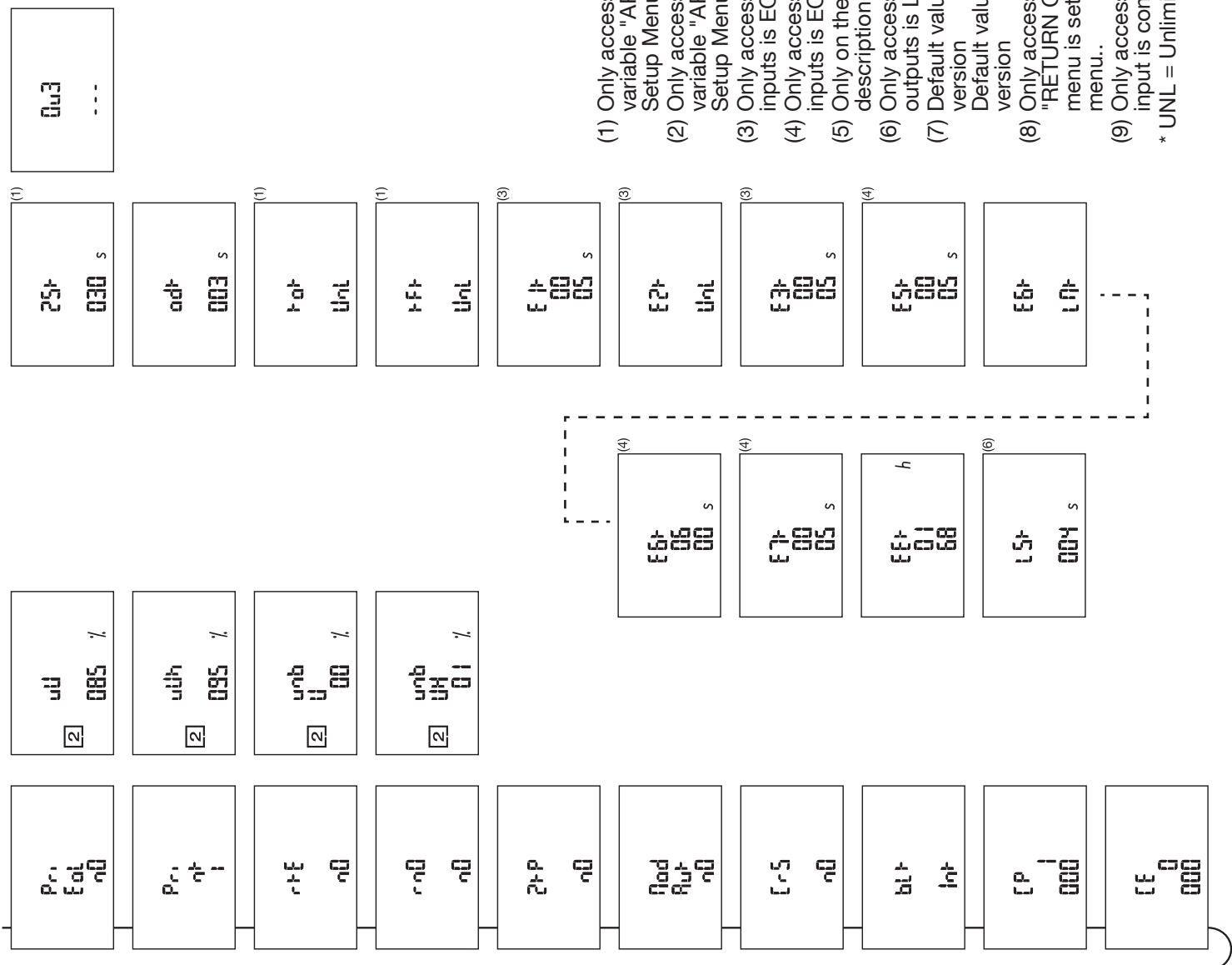

- (1) Only accessible if the Setup menu variable "APP" is at "M-G", see Setup Menu.
 - (2) Only accessible if the Setup menu variable "APP" is at "M-M", see Setup Menu.
 - (3) Only accessible if one of the inputs is EON, see I/O Menu.
 - (4) Only accessible if one of the inputs is EOF, see I/O Menu.
 - (5) Only on the COMM version, see description in the option section.
 - (6) Only accessible if one of the outputs is LSC, see I/O Menu.
 - (7) Default values: 230 V for 127/230 version
Default values: 400 V for 230/400 version
 - (8) Only accessible when the "RETURN O" variable in the Setup menu is set to "YES", see SETUP menu..
 - (9) Only accessible if the associated input is configured.
- * UNL = Unlimited

Architecture valid for ATyS p (master)

Parameters configuration	Set up	Voltage thresholds and hysteresis configuration	Frequency thresholds and hysteresis configuration	Power thresholds and hysteresis configuration	Timers configuration	Inputs/Outputs configuration	Communication module	Date and time configuration	Maintenance mode
	Set up	Vo llt	Fr	Pwr	tiM	I-O	Only with Comm/Eth opt Co MM	Dat tim	Mnt
	nt	[1] oU 100 %	[1] oF 105 %	[1] oP 0 k 000	1Ft 0 000 s	In 1 --- n0	dh cP no	Yr 10	rSt EVE no
	4 nbl	[1] oUH 100 %	[1] oFH 103 %	[1] oPH 0 k 000	1rt 0 000 s	In 2 --- n0	IP 1-2 000 000	Mon 01	crS no
	Aut Chf no	[1] uU 100 %	[1] uF 95 %	[2] oP 0 k 000	2Ft 0 000 s	In 3 --- n0	IP 3-4 000 000	dAY 01	rSt no
	rttr Aut	[1] uUH 100 %	[1] uFH 97 %	[2] oPH 0 k 000	2rt 0 000 s	In 4 --- n0	Gat 1-2 000 000	Hr 00	
	rot Aut	[1] unb U 01 %	[2] oF 105 %	[2] oP 0 k 000	2At 0 000 s	In 5 --- n0	Gat 3-4 000 000	Min 00	
	Un 400 V	[1] unb Uh 00 %	[2] oFH 103 %	[2] oPH 0 k 000	2ct 0 000 s	In 6 --- n0	MSK 1-2 000 000	SEC 00	
	Fn 50 Hz	[2] oU 100 %	[2] uF 95 %	[2] oP 0 k 000	2St 0 000 s	In 7 --- n0	MSK 3-4 000 000		
	APP M-M	[2] oUH 100 %	[2] uFH 97 %	[2] oPH 0 k 000	odt 0 000 s	In 8 --- n0	Add 005		
	Pri ton YES	[2] uU 100 %	[2] uF 95 %	[2] oP 0 k 000	tot LIM	In 9 --- n0	bd 9 k 600		
	Pri Eon YES	[2] uUH 100 %	[2] uFH 97 %	[2] oPH 0 k 000	(1) tot 0 000 s	In 10 --- n0	SIP 1		
	Pri net 0	[2] unb U 01 %	[2] uF 95 %	[2] oPH 0 k 000	(1) t3t 0 000 s	In 11 --- n0	Par no E		

umb	
Uh	
[2]	00 %

CT	
Pri	00
	000 %

CT	
SEC	
	1 %

S1	
sw2	no

bit	
Int	

Postcode	
	1
	000

CE	
	0
	000

bAc	
UP	
SAV	
E	

In	
12	---
	n0

In	
13	---
	n0

In	
14	---
	n0

Out	
1	---
	n0

Out	
2	---
	n0

Out	
3	---
	n0

Out	
4	---
	n0

Out	
5	---
	n0

Out	
6	---
	n0

Out	
7	---
	n0

Out	
8	---
	n0

Out	
9	---
	n0

(1) tft
LIM

(1) tft
0
000 s

(3) E1t
0
000 s

(3) E2t
LIM

(3) E2t
0
000 s

(3) E3t
0
000 s

(4) E5t
0
000 s

(4) E6t
LIM

(4) E6t
0
000 s

(4) E7t
0
000 s

(5) LSt
0
000 s

(6) EET
0
000 h

(6) EDT
0
000 s

- (1) Only accessible if the Setup menu variable "APP" is at "M-G", see Setup Menu
- (2) Only accessible if the Setup menu variable "APP" is at "M-M", see Setup Menu
- (3) Only accessible if one of the inputs is EON, see I/O Menu
- (4) Only accessible if one of the inputs is EOF, see I/O Menu
- (5) Only accessible if one of the outputs is LSC, see I/O Menu
- (6) Accessible only when output is EES

3.7. SoLive for Atys Bypass

1- Download Solive application

Scan one of the following QR codes to download your application:



2 - Create your Socomec cloud account or Log in

From SoLive App:

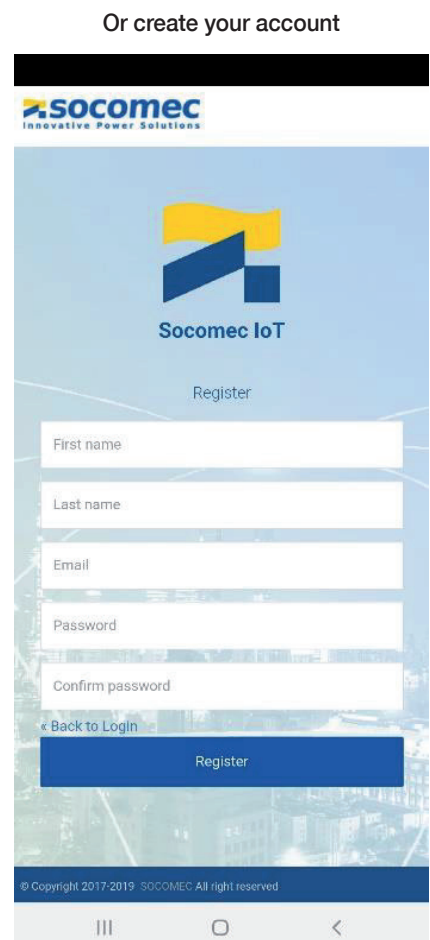

Fill the form and click [Register].
Then log in with your email address.

3. Register your mobile to cloud platform the first time or skip to step 4

Fill the form of Create an account:

The screenshot shows a mobile application interface for creating an account. At the top, there is a blue header with a back arrow and the text "Create an account". Below the header, the form consists of several sections: 1. "Language" with a dropdown menu set to "English". 2. "Country" with a dropdown menu set to "Select". 3. "Phone number" with a text input field containing "X XX XX XX XX". 4. A blue button labeled "VERIFY PHONE NUMBER". 5. "First name" with a text input field. 6. "Last name" with a text input field. 7. "Email" with a text input field. 8. A blue button labeled "VERIFY MAIL ADDRESS". 9. "Company" with a text input field. 10. "Activity" with a dropdown menu set to "Select". At the bottom of the form, there is a blue button labeled "CONTINUE". The bottom of the screen shows the standard Android navigation bar with three icons: a square, a circle, and a triangle.

3.1. Accept the terms and conditions

3.2. Enter the code received by SMS to verify your phone number

3.3. Click on the registration link received by email to verify your SoLive account.

4. Get the mobile App activation key

Open Webview-M "Cloud" configuration page in your browser.
Please refer to DIRIS Digiware gateway user manual to access Webview server.

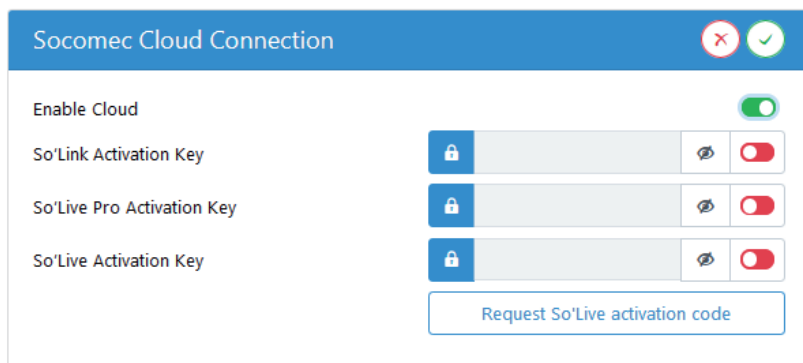

- 4.1. Enable "Cloud"
- 4.2. Enable Activation Key for "SoLive"
- 4.3. Click on [Ask code for SoLive]



A QR code with a code should appear

From SoLive application :

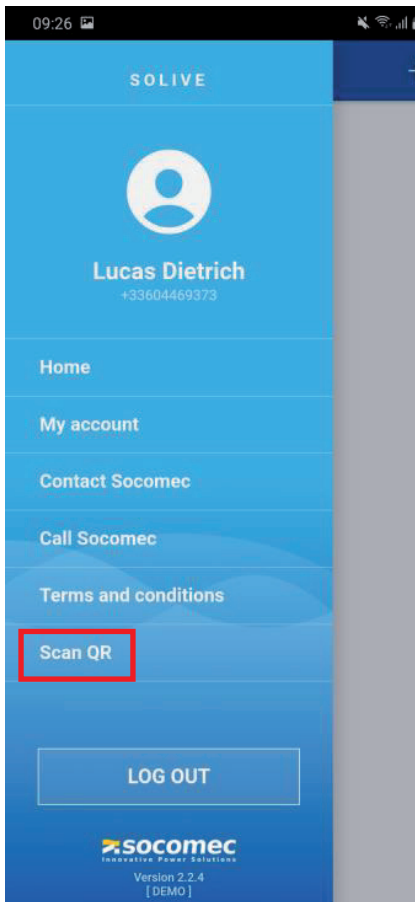

4.4. Click on "Scan QR"

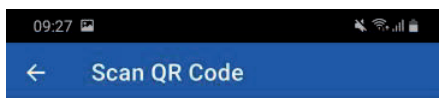

3.4. Copy the control code from Webview to SoLive

752725

3.5. Click "scan the QR code"



3.6. Scan the QR displayed in Webview

SCAN THE QR CODE



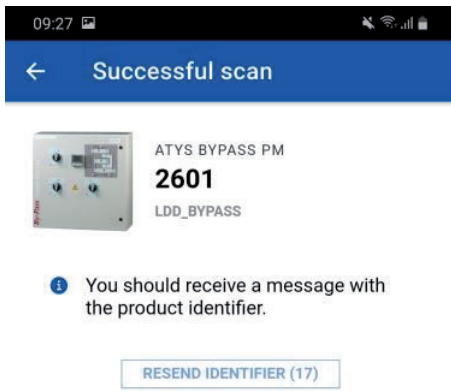

3.7. An SMS with the activation key is sent to your mobile phone.
The SMS looks as follow:



3.8. Click [resend] if no SMS is received

3.9. Click [Confirm]

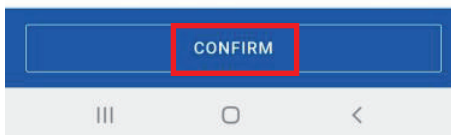

5 - Activating your Atys Bypass

From Webview "Cloud" configuration page

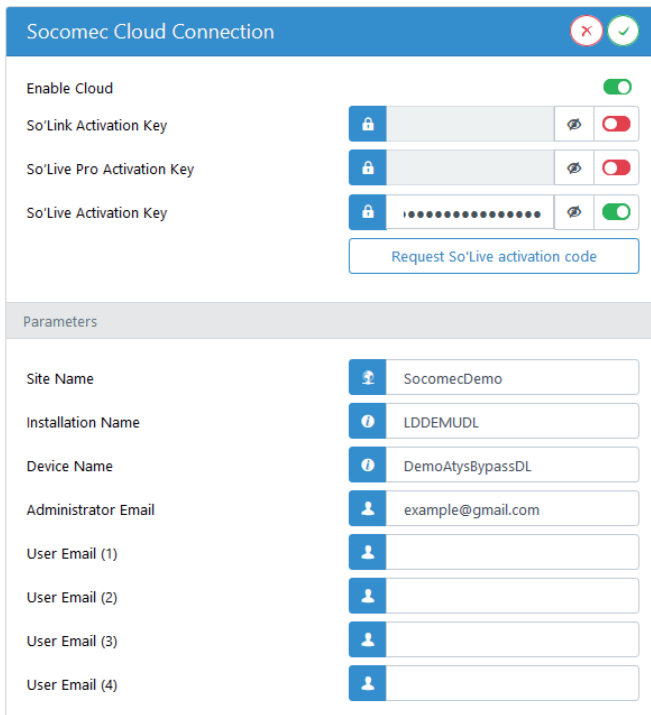

4.1. Copy the received activation key

4.2. Fill the remaining information:

- Site name
- Installation name
- Product name
- Email

4.3. You can add additional users authorized to monitor this device on their mobile.

4.4. Save your changes

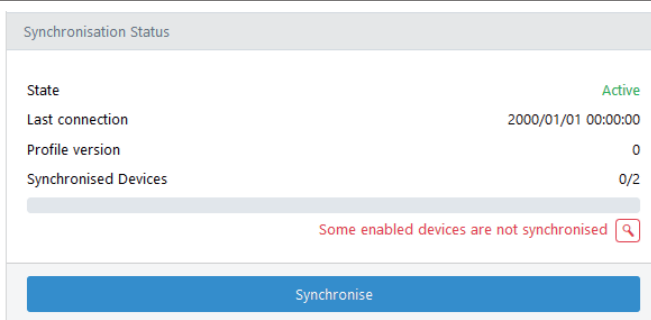

4.5. Click on "Synchronize"

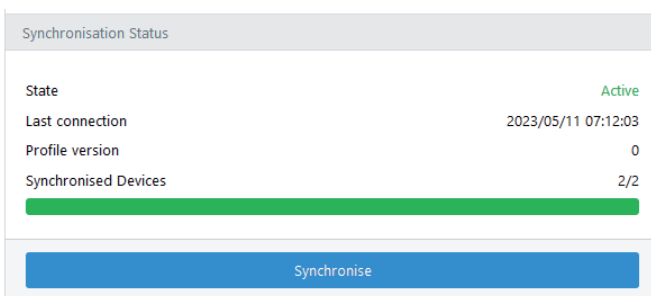

4.6. The state of the cloud should become active. In the case of an error, click on "Synchronize" again to restart the process. If no data present in SoLive after five minutes, please restart the synchronisation again.

Fields reported in SoLive App :

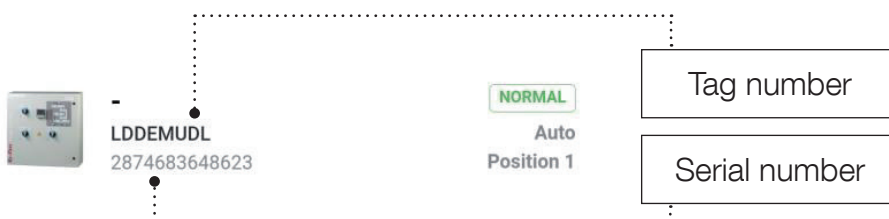

6 - Add your Atys Bypass in SoLive

On SoLive App:

Select « HOME » from hamburger menu.

5.1. Add a Product.

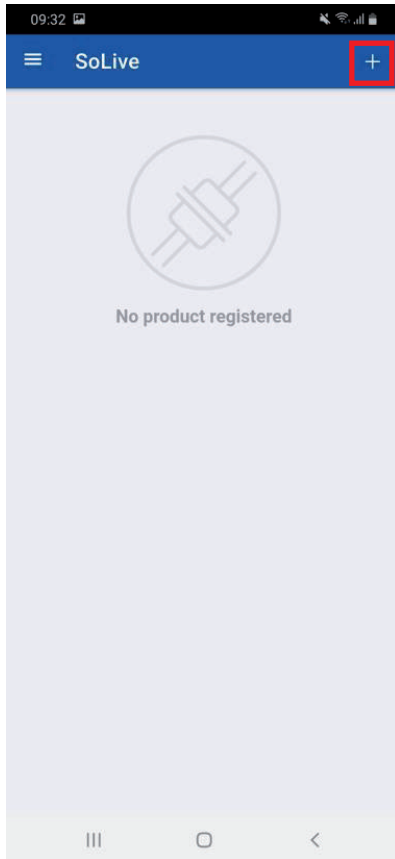

5.1. Select the Atys Bypass and click "Add selection".

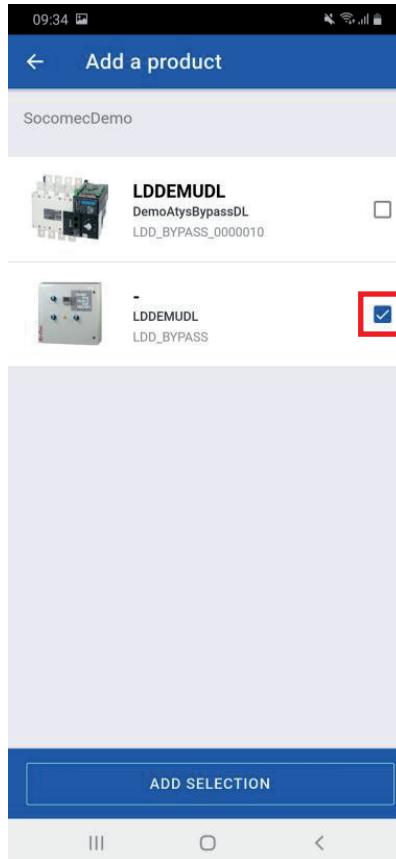

5.3. Your Atys Bypass can be monitored from the application.

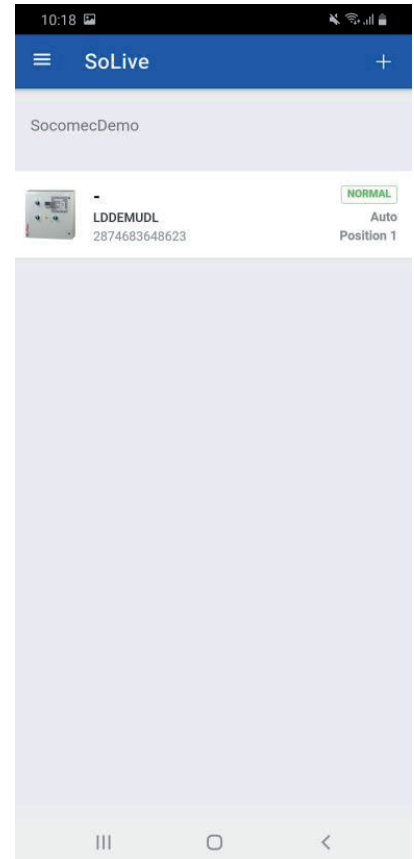

Atys Bypas Double Lines synoptic view:

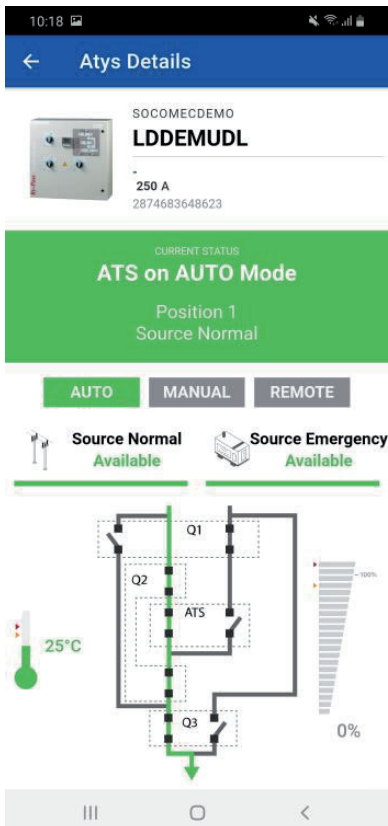

4. OPERATION

4.1. Equipment presentation

2 types of **ATS By-Pass** configurations are available from 40A to 3200A:

- The Double Line configuration
- The Single Line configuration

In both cases, the equipment:

- Ensures complete redundancy of the ATS function.
- Enables inspection, test and maintenance in simple way.
- Shows system status.
- Enables a safe operation.

In both cases, the equipment can be used in 3 functions: **Normal, By-Pass and Test.**

4.2. Exploitation: Double Line range

4.2.1. Initial position

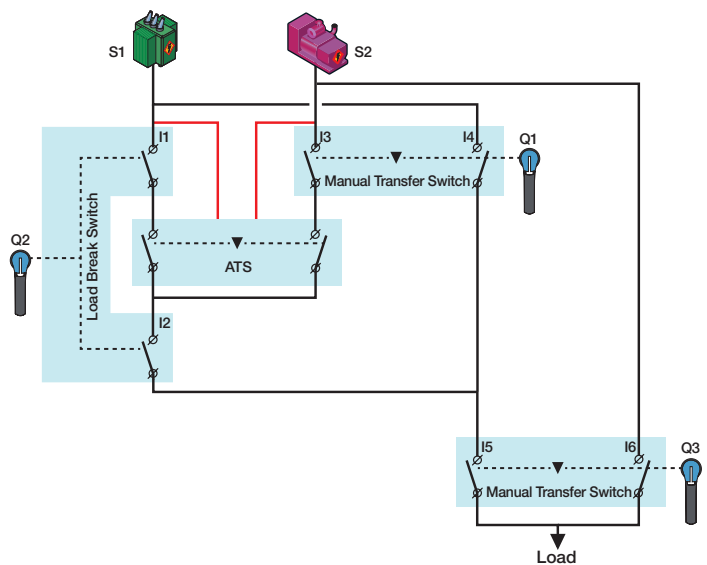
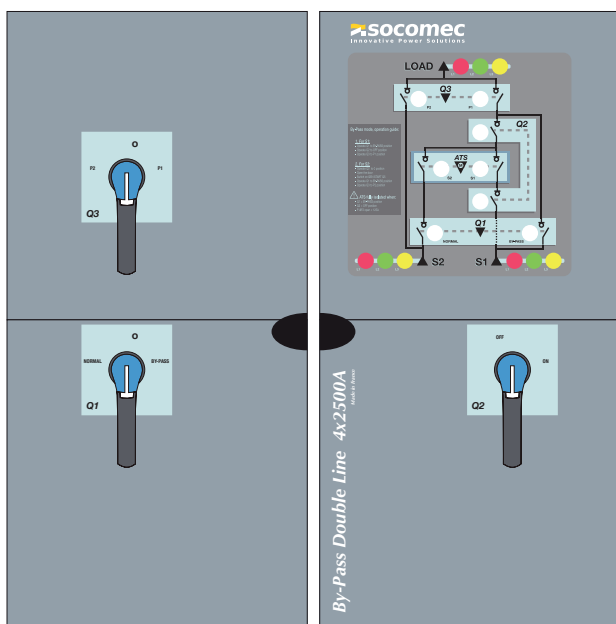

4.2.2. Normal function

Operation:

- 1 - Set Q1 handle to «Normal» position.
- 2 - Set Q2 handle to position «ON».
- 3 - Set Q3 handle to position «P1».

The ATS is used in a normal way.
In case of network absence, an automatic transfer is achieved to the available source.

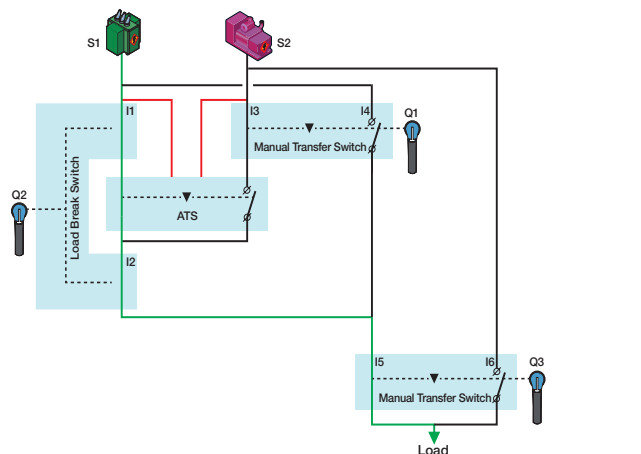

4.2.3. By-Pass Function

Operation for By-Pass on Source 1:

- 1 - Set Q1 handle to position «Bypass».
- 2 - Set Q2 handle to position «OFF».
- 3 - Set Q3 handle to position «P1».
The ATS is bypassed

Operation for By-Pass on Source 2:

- 1 - Set Q1 handle to position «Bypass».
- 2 - Set Q2 handle to position «OFF».
- 3 - Set Q3 handle to position «P2».
The ATS is bypassed.

In bypass mode, to send the signal to the genset in case of absence of source 1:

Switch all equipment to position 0.

- Open the door.

Set the 3-position changeover switch Q5 to position «Gen start».

Check that the genset is available and stable.

- close the door.
- Set Q3 handle to position «P2».

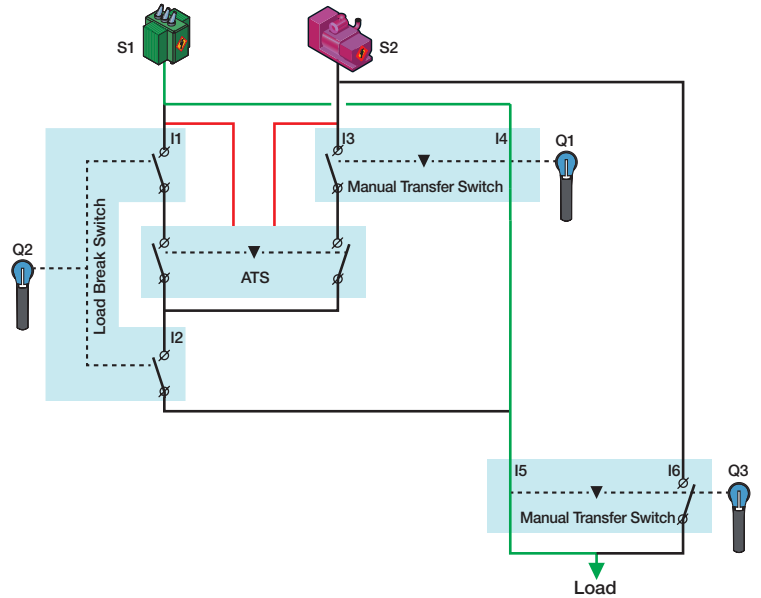

4.2.4. Test function

Operation Test Off Load:

- from 0 A to 125 A : after initiation the generator will be ordered to start however its availability will not be monitored by the ATS and the message «FAIL START» will be displayed after timer 2ST reaches zero.

- 1 - Set Q1 handle to «bypass» position.
 - 2 - Set Q2 handle to position «ON».
 - 3 - Set Q3 handle to position «P1» when «S1» is available.
- from 160 A to 3200 A:
- 1 - Set Q1 handle to «bypass» position.
 - 2 - Set Q2 handle to position «ON».
 - 3 - Set Q3 handle to position «P1» when «S1» is available.

Operation Test On Load:

- from 0 A to 125 A: impossible
- from 160 A to 3200 A:
- 1 - Set Q1 handle to «bypass» position.
 - 2 - Set Q2 handle to position «ON».
 - 3 - Set Q3 handle to position «P1» when «S1» is available.

V. Isolation of the ATS

Operation:

- 1 - Set Q1 handle to «bypass» position.
- 2 - Set Q2 handle to position «OFF».
- 3 - For ratings <125 A, open fuse holders F1 & F2.

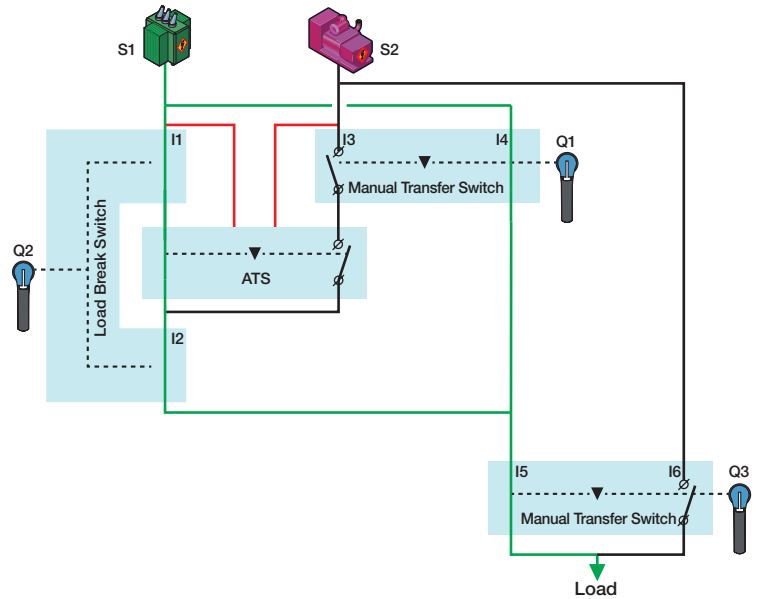

4.3. Exploitation: Single Line range

4.3.1. Initial position

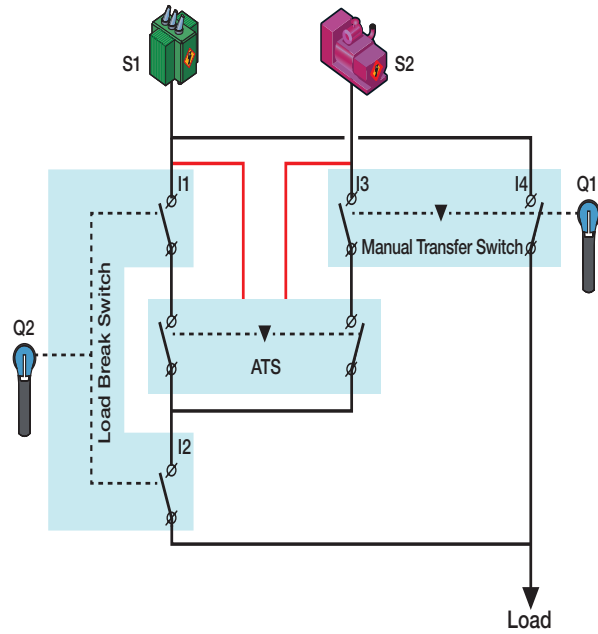
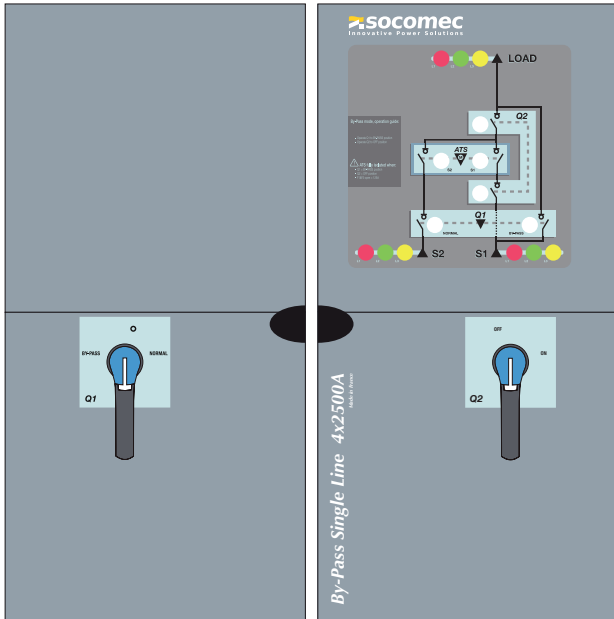

4.3.2. Normal function

Operation:

- 1 - Set Q1 handle to «Normal» position.
- 2 - Set Q2 handle to position «ON».

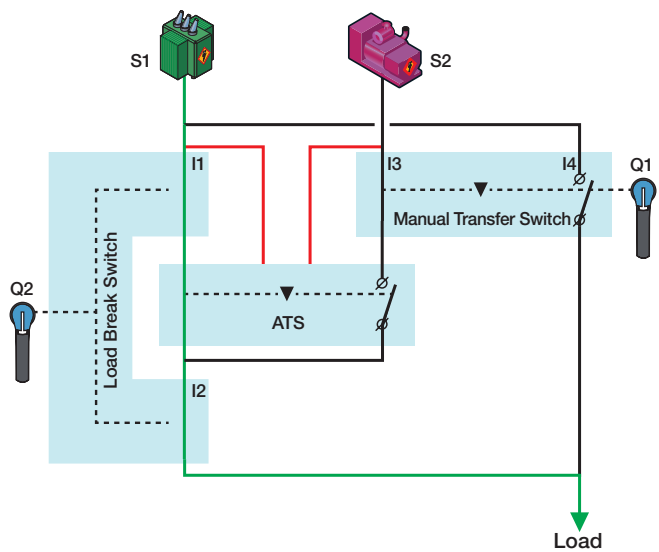

4.3.3. By-Pass Function

The ATS is bypassed.
The second bypass line must be activated.

Operation for By-Pass on Source 1:

- 1 - Set Q1 handle to «bypass» position.
- 2 - Set Q2 handle to position «OFF».
The ATS is bypassed

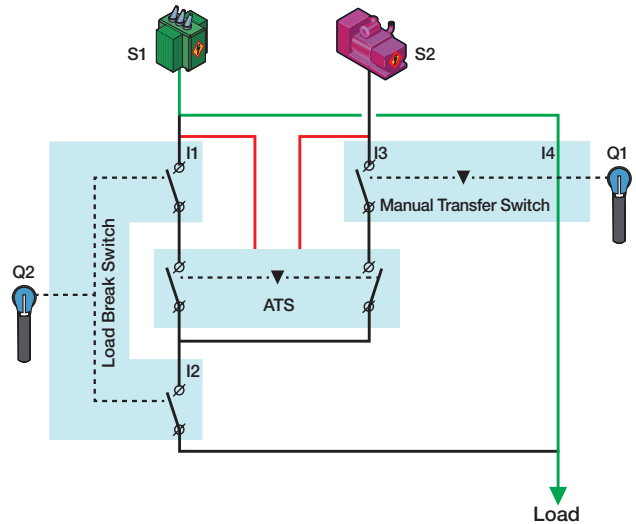

4.3.4. Test function

Operation Test Off Load:

- from 0 A to 125 A : after initiation the generator will be ordered to start however its availability will not be monitored by the ATS and the message «FAIL START» will be displayed after timer 2ST reaches zero.

- 1 - Set Q1 handle to «bypass» position.
 - 2 - Set Q2 handle to position «ON».
 - 3 - Set Q3 handle to position «P1» when «S1» is available.
- from 160 A to 3200 A:
- 1 - Set Q1 handle to «bypass» position.
 - 2 - Set Q2 handle to position «ON».
 - 3 - Set Q3 handle to position «P1» when «S1» is available.

Operation Test On Load:

- from 0 A to 125 A: impossible
- from 160 A to 3200 A:
- 1 - Set Q1 handle to position «Bypass».
 - 2 - Set Q2 handle to position «ON».

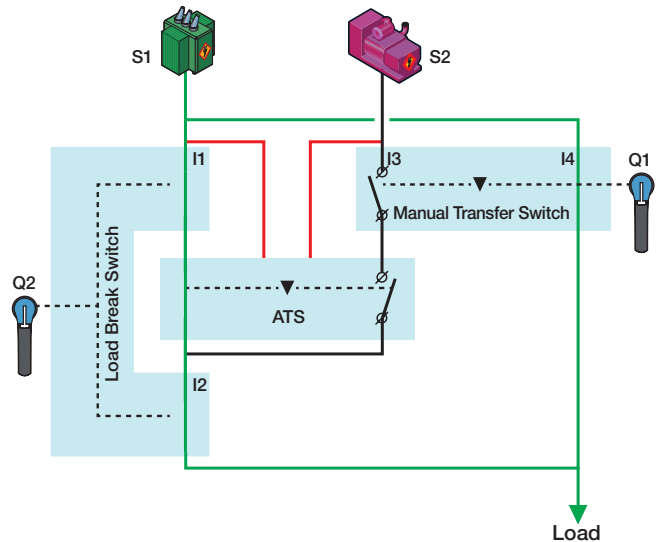

4.3.5. Isolation of the ATS

Operation:

- 1 - Set Q1 handle to «bypass» position.
- 2 - Set Q2 handle to position «OFF».
- 3 - For ratings > 125 A, open fuse holders F1 & F2.

4.4. Visualization

In order to have a user friendly visualization and use of the enclosed solution, the equipment is factory fitted with a synoptic and a remote interface D20.

The standard synoptic will enable instantaneous visualization of the available sources and load through 3 LEDs (16 mm).

For a better visualization of the system (position of the switches, indication of source phases), an optional 17-Led synoptic is available.

Synoptic (factory mounted).

Double Line range

I. Synoptic 17 LEDs

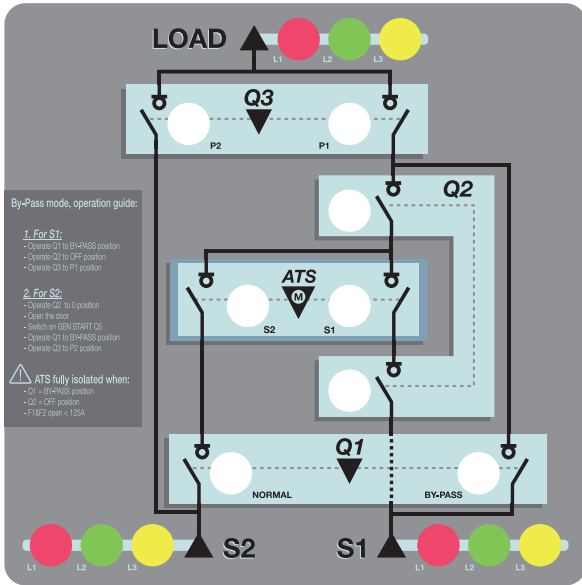

II. Synoptic 3 LEDs

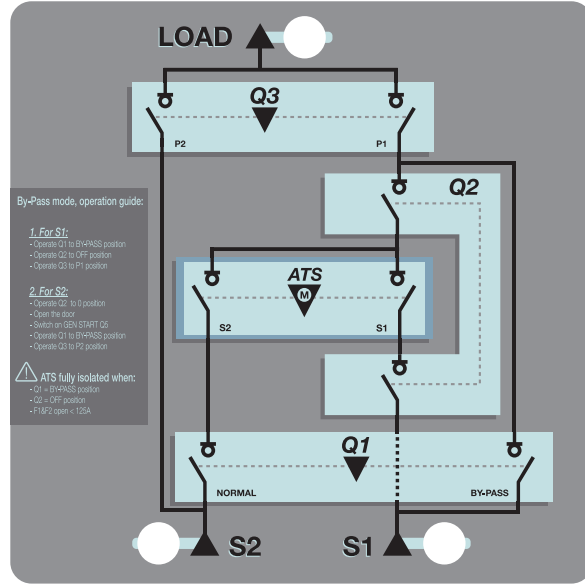

Single Line range

I. Synoptic 15 LEDs

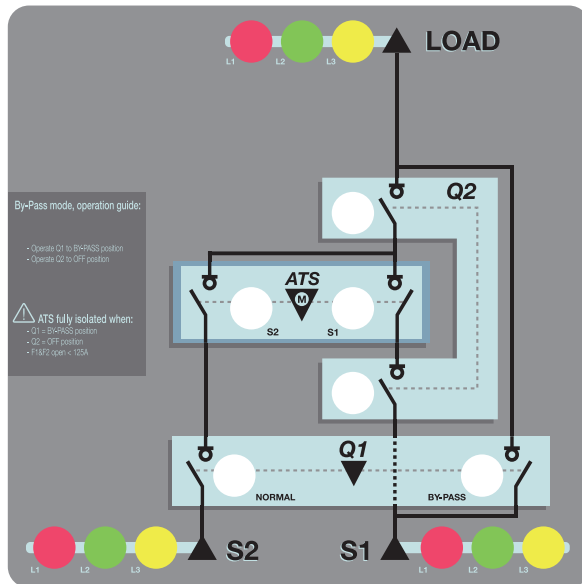

II. Synoptic 3 LEDs

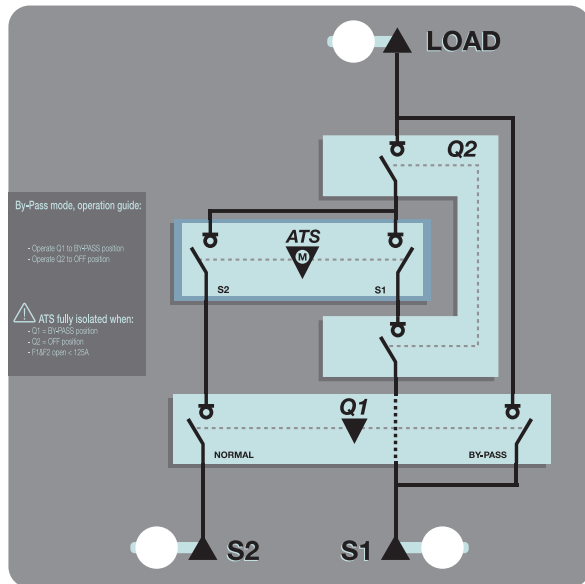

The D20, allows remote display of transfer system: positions, sources availability, operational mode and metering. The remote interface allows controlling, testing and programming of all ATS parameters*.



4.5. Communication

In order to better meet customers' requirements, RS485 JBUS/MODBUS communication facilities are available on the full 40 to 3200 A range.

From 40A to 125A, the ATyS p M products includes a RS485 communication.

From 160A to 3200A, a RS485 communication module is plugged directly to the ATyS p.

4.5.1. ATyS p M

JBUS/MODBUS® protocol

The Modbus® protocol used by the ATyS requires a dialogue using a master/slave hierarchical structure.

Two dialogues are possible:

- the master communicates with a slave (ATyS) and waits for its reply,
- the master communicates with all the slaves (ATyS) without waiting for their reply.

The mode of communication is the RTU (Remote Terminal Unit) using hexadecimal characters of at least 8 bits.

In the communication protocol, a standard frame is made up of the following elements:



- Slave address: Communicating device address (Add, menu Comm parameters)
- Function code: the codes which can be used are as follows:
 - 3 : to read n words (maximum 125)
 - 6 : to write one word
 - 16 : to write n words (maximum 125).
- Address : Register address (refer to following tables)
- Data : Parameters linked to function (number of words, value)

When slave address 0 is selected, a message is sent to all devices present on the network (only for functions 6 and 16); this type of message is called general distribution, so it is not followed up with a response from the slaves.

The maximum response time (timeout) is 250 ms between a question and a response.

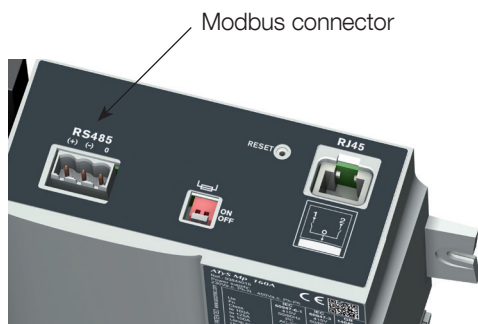

Function 3

Dec. address.	Hex. address.	No. of words	Designation	Unit
Status				
20480	5000	1	Type of network 1: 127 - 230 V 2: 230 - 400 V	
20481	5001	1	Operating mode 0x0000: Manual mode 0x0010: Automatic mode 0x0020: Control mode 0x0040: Inhibited mode	
20482	5002	1	Position 1: Position 0 2: Position I 3: Position II	
20484	5004	1	Genset starting order status, source II 0: Inactive 1: Active	
20485	5005	1	Priority 0: Network 1: Source I 2: Source II	
20486	5006	1	Source I status 0: No source 1: Out of thresholds 2: Available	
20487	5007	1	Source II status 0: No source 1: Out of thresholds 2: Available	
20488	5008	1	Test in progress 0x0000: None 0x0001: TOF 0x0002: EOF 0x0004: TON 0x0008: EON	
20489	5009	1	Cycle counter	
20490	500A	1	Operations to position I counter	
20491	500B	1	Operations to position II counter	
20492	500C	1	Fault signal 0: None 1: Alarm 2: Fault	
20493	500D	1	Alarm / fault code 0: None 1: F00 Op Fct 2: F03 Neutral 3: F11 FLT - 1 4: F21 FLT - 2 5: F12 ALR - 1 6: F22 ALR - 2 7: F13 ROT - 1 8: F23 ROT - 2 9: F14 CAP - 1 10: F24 CAP - 2 11: F15 PWR - 1 12: F25 PWR - 2 13: F16 POS - 1 14: F26 POS - 2 15: F06 POS - 0	
20494	500E	1	Cause of last switchover 0: None 1: Manual 2: under-voltage I 3: under-voltage II 4: Overvoltage source I 5: Overvoltage source II 6: Source under-frequency I 7: Source under-frequency II 8: Source over-frequency I 9: Source over-frequency II 10: Source phases unbalanced I 11: Source II 12: Direction of rotation inverted on source I 13: Direction of rotation inverted on source II	

Functions 3, 6 and 16

Dec. address.	Hex. address.	No. of words	Designation	Unit
Time delay configuration				
21760	5500	1	Loss of source <input type="checkbox"/> : 1FT	S
21761	5501	1	Source <input type="checkbox"/> return: 1RT	S
21763	5503	1	Source <input type="checkbox"/> return to 0: 1OT	S
21765	5505	1	Source <input type="checkbox"/> loss: 2FT	S
21766	5506	1	Source <input type="checkbox"/> return: 2RT (Appli M-M) or Source <input type="checkbox"/> stabilisation: 2AT (Appli M-G)	S
21767	5507	1	Source <input type="checkbox"/> request maintained: 2CT	S
21768	5508	1	Source <input type="checkbox"/> return to 0: 2OT	S
21769	5509	1	Source <input type="checkbox"/> starting timeout: 2ST	S
21770	550A	1	Time without electricity: 0DT	S
21771	550B	1	0: TOT limited - 1: TOT unlimited	S
21772	550C	1	Test On Load duration timer: TOT	S
21773	550D	1	0: TFT limited - 1: TFT unlimited	
21774	550E	1	Test Off Load duration timer: TFT	S
21775	550F	1	0: E2T limited - 1: E2T unlimited	S
21776	5510	1	On Load external operation request timer (start): E1T	S
21777	5511	1	On Load external operation request timer (end): E3T	S
21778	5512	1	On Load external operation request timer (duration): E2T	S
21779	5513	1	Off Load external operation request timer (start): E5T	S
21780	5514	1	Off Load external operation request timer (duration): E7T	S
21781	5515	1	Off Load external operation request timer (duration): E6T	S
21782	5516	1	Load shedding timer: LST	S
Threshold configurations				
21840	5550	1	Source <input type="checkbox"/> : Voltage upper threshold	
21841	5551	1	Source <input type="checkbox"/> : Voltage upper threshold hysteresis	
21842	5552	1	Source <input type="checkbox"/> : Voltage lower threshold	
21843	5553	1	Source <input type="checkbox"/> : Voltage lower threshold hysteresis	
21844	5554	1	Source <input type="checkbox"/> : Voltage upper threshold	
21845	5555	1	Source <input type="checkbox"/> : Voltage upper threshold hysteresis	
21846	5556	1	Source <input type="checkbox"/> : Voltage lower threshold	
21847	5557	1	Source <input type="checkbox"/> : Voltage lower threshold hysteresis	
21848	5558	1	Source <input type="checkbox"/> : Phase unbalance threshold	
21849	5559	1	Source <input type="checkbox"/> : Phase unbalance threshold hysteresis	
21850	555A	1	Source <input type="checkbox"/> : Phase unbalance threshold	
21851	555B	1	Source <input type="checkbox"/> : Phase unbalance threshold hysteresis	
21852	555C	1	Source <input type="checkbox"/> : Frequency upper threshold	
21853	555D	1	Source <input type="checkbox"/> : Frequency upper threshold hysteresis	
21854	555E	1	Source <input type="checkbox"/> : Frequency lower threshold	
21855	555F	1	Source <input type="checkbox"/> : Frequency lower threshold hysteresis	
21856	5560	1	Source <input type="checkbox"/> : Frequency upper threshold	
21857	5561	1	Source <input type="checkbox"/> : Frequency upper threshold hysteresis	
21858	5562	1	Source <input type="checkbox"/> : Frequency lower threshold	
21859	5563	1	Source <input type="checkbox"/> : Frequency lower threshold hysteresis	

Dec. address.	Hex. address.	No. of words	Designation	Unit
Network configuration				
22096	5650	1	Type of network	
			0: 4NBL (230/400V) 1: 1BL (230/400V) 2: 41NBL (230/400V) 3: 42NBL (230/400V) 4: 3NBL (230/400V)	5: 4NBL (127/230V) 6: 3NBL (127/230V) 7: 2NBL (127/230V) 8: 2BL (127/230V) 9: 42NBL (127/230V)
22097	5651	1	Neutral (0) AUTO on the right	1: neutral on the left 2: Neutral
22098	5652	1	Direction of phase rotation 0: Undefined	1: ABC 2: ACB
22099	5653	1	Rated voltage 180 <= Unom <= 480	
22100	5654	1	Rated frequency 0: 50Hz	1: 60 Hz
22101	5655	1	Application type: 0: Network - Network (M-M)	1: Network - genset (M-G)
22103	5657	1	Genset starting relay 0: NO	1: NC
22104	5658	1	PRIO NET 0: none	1: source <input type="checkbox"/> 2: Source <input type="checkbox"/>
22105	5659	1	PRIO TON 0: NO	1: YES
22106	565A	1	PRIO EON 0: NO	1: YES
22107	565B	1	RETRANS 0: NO	1: YES
22108	565C	1	RETURN O 0: NO	1: YES
22110	565E	1	2ND TRIP 0: NO	1: YES
22111	565F	1	MOD AUT 0: NO	1: YES
22112	5660	1	BACKLIGHT 0: OFF	1: ON 2: INT

Inputs / outputs configuration				
22352	5750	1	Function IN 1 0: /	
22353	5751	1	Function IN 2 0: /	
22354	5752	1	Function IN 3 0: /	
22355	5753	1	IN 1 status	0: NO 1: NC
22356	5754	1	IN 2 status	0: NO 1: NC
22357	5755	1	IN 3 status 0: NO	1: NC
22358	5756	1	Function OUT 1 0: /	
22359	5757	1	Function OUT 2 0: /	
22360	5758	1	Function OUT 3 0: /	

Inputs	Outputs
1: INH	1: S1A
2: tol	2: S2A
3: TOF	3: SCA
4: EON	4: AC1
5: EOF	5: AC2
6: MSR	6: AC0
7: RTC	7: LO1
8: PRI	8: LO2
9: SS1	9: LSC
10: SS2	10: FLT
11: PS1	11: POP
12: PS2	12: CP1
13: PS0	13: CP2
14: AL1	14: CP3
15: AL2	
16: FT1	
17: FT2	
18: OA1	
19: OA2	
20: RST	
21: LSI	

4.5.2. ATyS p



Note: to authorise a change in configuration: define adress HEXA E300 as 1000.

4.5.2.1. Metrology Affected by current and voltage transformers

Function 3 Codes

Dec. Address	Hex. Address	Words count	Description	Unit
50514	C552	2	Phase to Phase Voltage: U12	V/100
50516	C554	2	Phase to Phase Voltage: U23	V/100
50518	C556	2	Phase to Phase Voltage: U31	V/100
50520	C558	2	Simple voltage: V1	V/100
50522	C55A	2	Simple voltage: V2	V/100
50524	C55C	2	Simple voltage: V3	V/100
50526	C55E	2	Frequency: F	Hz/100
50528	C560	2	Current: I1	mA
50530	C562	2	Current: I2	mA
50532	C564	2	Current: I3	mA
50534	C566	2	Neutral Current: In	mA
50536	C568	2	\sum Active Power \pm : P	kW/100 (Signed)
50538	C56A	2	\sum Reactive Power \pm : Q	kvar/100 (Signed)
50540	C56C	2	\sum Apparent Power: S	kVA/100
50542	C56E	2	\sum Power Factor: - : leading et + : lagging: PF	0,001 (Signed)
50544	C570	2	Active Power phase 1 \pm : P1	kW/100 (Signed)
50546	C572	2	Active Power phase 2 \pm : P2	kW/100 (Signed)
50548	C574	2	Active Power phase 3 \pm : P3	kW/100 (Signed)
50550	C576	2	Reactive Power phase 1 \pm : Q1	kvar/100 (Signed)
50552	C578	2	Reactive Power phase 2 \pm : Q2	kvar/100 (Signed)
50554	C57A	2	Reactive Power phase 3 \pm : Q3	kvar/100 (Signed)
50556	C57C	2	Apparent Power phase 1: S1	kVA/100
50558	C57E	2	Apparent Power phase 2: S2	kVA/100
50560	C580	2	Apparent Power phase 3: S3	kVA/100
50562	C582	2	Power Factor phase 1 - : leading and + : lagging : PF1	0,001 (Signed)
50564	C584	2	Power Factor phase 2 - : leading and + : lagging : PF2	0,001 (Signed)
50566	C586	2	Power Factor phase 3 - : leading and + : lagging : PF3	0,001 (Signed)

4.5.2.2. Energy

Function 3 Codes

Dec. Address	Hex. Address	Words count	Description	Unit
50770	C652	2	Total Positive Active Energy (no resetable): Ea+	kWh
50772	C654	2	Total Positive Reactive Energy (no resetable): Er +	kvarh
50774	C656	2	Total Apparent Energy (no resetable): Es	kVAh
50776	C658	2	Total Negative Active Energy (no resetable): Ea-	kWh
50778	C65A	2	Total Negative Reactive Energy (no resetable): Er -	kvarh
50780	C65C	2	Partial Positive Active Energy: Ea+	kWh
50782	C65E	2	Partial Positive Reactive Energy: Er +	kvarh
50784	C660	2	Partial Apparent Energy : Es	kVAh
50786	C662	2	Partial Negative Active Energy : Ea-	kWh
50788	C664	2	Partial Negative Reactive Energy : Er -	kvarh

4.5.2.3. Metrology not affected by current and voltage transformers

Function 3 Codes

Dec. Address	Hex. Address	Words count	Description	Unit
51281	C851	1	Phase to Phase Voltage: U12	V/100
51282	C852	1	Phase to Phase Voltage: U23	V/100
51283	C853	1	Phase to Phase Voltage: U31	V/100
51284	C854	1	Simple voltage: V1	V/100
51285	C855	1	Simple voltage: V2	V/100
51286	C856	1	Simple voltage: V3	V/100
51287	C857	1	Frequency: F	Hz/100
51288	C858	1	Current: I1	mA
51289	C859	1	Current: I2	mA
51290	C85A	1	Current: I3	mA
51291	C85B	1	Neutral Current: In	mA
51292	C85C	1	\sum active Power \pm : P	kW/100 (Signed)
51293	C85D	1	\sum reactive Power \pm : Q	kvar/100 (Signed)
51294	C85E	1	\sum apparent power: S	kVA/100
51295	C85F	1	\sum power factor: -: leading and +: lagging: PF	0,001 (Signed)
51296	C860	1	Active Power phase 1 \pm : P1	kW/100 (Signed)
51297	C861	1	Active Power phase 2 \pm : P2	kW/100 (Signed)
51298	C862	1	Active Power phase 3 \pm : P3	kW/100 (Signed)
51299	C863	1	Reactive Power phase 1 \pm : Q1	kvar/100 (Signed)
51300	C864	1	Reactive Power phase 2 \pm : Q2	kvar/100 (Signed)
51301	C865	1	Reactive Power phase 3 \pm : Q3	kvar/100 (Signed)
51302	C866	1	Apparent power phase 1: S1	kVA/100
51303	C867	1	Apparent power phase 2: S2	kVA/100
51304	C868	1	Apparent power phase 3: S3	kVA/100
51305	C869	1	Power Factor phase 1 -: leading and +: lagging : PF1	0,001 (Signed)
51306	C86A	1	Power Factor phase 2 -: leading and +: lagging : PF2	0,001 (Signed)
51307	C86B	1	Power Factor phase 3 -: leading and +: lagging : PF3	0,001 (Signed)
51311	C86F	1	Total Positive Active Energy (no resetable): Ea+	MWh
51312	C870	1	Total Positive Reactive Energy (no resetable): Er +	Mvarh
51313	C871	1	Total Negative Active Energy (no resetable): Ea-	MWh
51314	C872	1	Total Negative Reactive Energy (no resetable): Er -	Mvarh

4.5.2.4. Input/Output state

Function 3 Codes

Dec. Address	Hex. Address	Words count	Description	Unit
51968	CB00	1	Input count	
51969	CB01	1	Bit 0: Input 1 Open or Closed Bit x: Input x +1 Open or Closed	
51970	CB02	1	Output count	
51971	CB03	1	Bit 0: Output 1 Open or Closed Bit x: Output x +1 Open or Closed	

4.5.2.5. Network setting

Function 3, 6 and 16 Codes

Dec. Address	Hex. Address	Words count	Description	Unit
57345	E001	1	Current Transformer secondary: 1: 1 A 5: 5 A	
57346	E002	1	Current Transformer primary	A

4.5.2.6. Hour/Date setting

Function 3 and 16 Codes

Dec. Address	Hex. Address	Words count	Description	Unit
57600	E100	1	Day	
57601	E101	1	Month	
57602	E102	1	Year	
57603	E103	1	Hour	
57604	E104	1	Minute	
57605	E105	1	Second	

4.5.2.7. Ethernet module interface

Function 3, 6 and 16 Codes

Dec. Address	Hex. Address	Words count	Description	Unit
57616	E110	1	Ethernet IP address - part 1	0 - 255
57617	E111	1	Ethernet IP address - part 2	0 - 255
57618	E112	1	Ethernet IP address - part 3	0 - 255
57619	E113	1	Ethernet IP address - part 4	0 - 255
57620	E114	1	Ethernet GATE - part 1	0 - 255
57621	E115	1	Ethernet GATE - part 2	0 - 255
57622	E116	1	Ethernet GATE - part 3	0 - 255
57623	E117	1	Ethernet GATE - part 4	0 - 255
57624	E118	1	Ethernet MASK - part 1	0 - 255
57625	E119	1	Ethernet MASK - part 2	0 - 255
57626	E11A	1	Ethernet MASK - part 3	0 - 255
57627	E11B	1	Ethernet MASK - part 4	0 - 255
57628	E11C	1	DHCP used 1: yes 0: no	
57629	E11D	1	MODBUS gateway enabled 1: yes 0: no	
57630	E11E	1	MODBUS RTU over Ethernet Enabled 1: yes 0: no	
57631	E11F	1	Gateway External MODBUS Baudrate enumeration 0: 2400 bps 1: 4800 bps 2: 9600 bps 3: 19200 bps 4: 38400 bps	
57632	E120	1	Gateway External MODBUS Parity 0: none 1: even 2: odd	

Dec. Address	Hex. Address	Words count	Description	Unit
57633	E121	1	Gateway External MODBUS Stopbit 0: 1 stop bit 1: 2 stop bits	
57634	E122	1	MODBUS Gateway Master request timeout	ms
57635	E123	1	MODBUS Slave address (RS485 & RTU over Ethernet)	1-247

4.5.2.8. Action system

Function 6 Codes

Dec. Address	Hex. Address	Words count	Description	Unit
57856	E200	1	Action: 0xA1: Product Configuration storage 0xB2: Product reset	

4.5.2.9. Status

Function 6 Codes

Dec. Address	Hex. Address	Words count	Description	Unit
20480	5000	2	Date & Time Current	-
20482	5002	1	Operating Mode 0x0000: Manual Mode 0x0001: Locked Mode 0x0010: Auto Mode 0x0020: Remote control mode 0x0040: Inhibit Mode	
20483	5003	1	Switch Position 0: Unknown 1: Position 0 2: Position I 3: Position II	
20484	5004	1	Source 2 Start Generator relay State 0: Not Active 1: Active	
20485	5005	1	Priority 0: Network 1: Source 1 2: Source 2	
20486	5006	1	Source1 State 0: Under Threshold BusBar 1: Present 2: Available	
20487	5007	1	Source2 State 0: Under Threshold BusBar 1: Present 2: Available	
20488	5008	1	Test in progress 0x0000: None 0x0001: TOF 0x0002: EOF 0x0004: TON 0x0008: EON	
20489	5009	1	Fault summary 0: None 1: Alarm 2: Fault	

Dec. Address	Hex. Address	Words count	Description	Unit
20490	500A	1	Alarm/Fault Code 0x0001: Operating factor (Alarm) 0x0002: Neutral position (Alarm) 0x0004: External fault 1 (Fault) 0x0008: External fault 2 (Fault) 0x0010: Alarm 1 (Alarm) 0x0020: Alarm 2 (Alarm) 0x0040: Source 1 rotation (Alarm) 0x0080: Source 2 rotation (Alarm) 0x0100: Source 1 unbalanced 1 (Alarm) 0x0200: Source 2 unbalanced 2 (Alarm) 0x0400: Position 0 (Fault) 0x0800: Position I (Fault) 0x1000: Position II (Fault) 0x2000: Main fault (Fault) 0x4000: Motor fault (Fault) 0x8000: Autoconfiguration failed (Alarm)	
20491	500B	1	Last Switch over cause 0: None 1: Manual 2: Remote controlled 3: Under voltage source 1 4: Under voltage source 2 5: Over voltage source 1 6: Over voltage source 2 7: Under Frequency source 1 8: Under Frequency source 2 9: Over Frequency source 1 10: Over Frequency source 2 11: Unbalance Source 1 12: Unbalance Source 2 13: Rotation Source 1 14: Rotation Source 2	
20492	500C	2	Firmware last flash date	-
20494	500E	2	Date of first commissioning	-
20496	5010	8	Product identification	-
20504	5018	1	Power supply status 0: No network present for DPS 1: Source 1 present for DPS 2: Source 2 present for DPS 3: Sources 1+2 present for DPS	
20505	5019	1	Source 1: Phase 1 presence 1: Present 0: Absent	
20506	501A	1	Source 1: Phase 2 presence 1: Present 0: Absent	
20507	501B	1	Source 1: Phase 3 presence 1: Present 0: Absent	
20508	501C	1	Source 2: Phase 1 presence 1: Present 0: Absent	
20509	501D	1	Source 2: Phase 2 presence 1: Present 0: Absent	
20510	501E	1	Source 2: Phase 3 presence 1: Present 0: Absent	
20511	501F	1	BET Mode 0: Not present 1: Auto 2: Manual 3: Remote control 4: Locked	

Dec. Address	Hex. Address	Words count	Description	Unit
20512	5020	1	BET Available 0: Not available 1: Available	
20513	5021	1	Product is available 0: Not available 1: Available	

4.5.2.10. Engine exerciser - custom time range status

Function 3 Codes

Dec. Address	Hex. Address	Words count	Description	Unit
20560	5050	2	Date & Time current	sec.
20562	5052	1	Next custom range to be activated 0: None 1: Custom 1 2: Custom 2 3: Custom 3 4: Custom 4	
20563	5053	2	Next custom range start date	sec.
20565	5055	2	Next custom range stop date	sec.
20567	5057	2	Next custom range start delay	sec.

4.5.2.11. Measurement table (no CT/VT affected)

Function 3 Codes

Dec. Address	Hex. Address	Words count	Description	Unit
20736	5100	2	Date & Time current	sec.

Down Stream Voltage

20738	5102	1	U12	V/100
20739	5103	1	U23	V/100
20740	5104	1	U31	V/100
20741	5105	1	V1	V/100
20742	5106	1	V2	V/100
20743	5107	1	V3	V/100
20744	5108	1	Fr	Hz/100

Up Stream Voltage

20745	5109	1	Source 1: U12	V/100
20746	510A	1	Source 1: U23	V/100
20747	510B	1	Source 1: U31	V/100
20748	510C	1	Source 1: V1	V/100
20749	510D	1	Source 1: V2	V/100
20750	510E	1	Source 1: V3	V/100
20751	510F	1	Source 1: F	Hz/100
20752	5110	1	Source 2: U12	V/100
20753	5111	1	Source 2: U23	V/100
20754	5112	1	Source 2: U31	V/100
20755	5113	1	Source 2: V1	V/100
20756	5114	1	Source 2: V2	V/100
20757	5115	1	Source 2: V3	V/100
20758	5116	1	Source 2: F	Hz/100

Down Stream Current				
20759	5117	1	I1	mA
20760	5118	1	I2	mA
20761	5119	1	I3	mA
20762	511A	1	Ineutral	mA

Power				
20763	511B	2	Active Power phase 1	W / 100
20765	511D	2	Active Power phase 2	W / 100
20767	511F	2	Active Power phase 3	W / 100
20769	5121	2	Reactive Power phase 1	var / 100
20771	5123	2	Reactive Power phase 2	var / 100
20773	5125	2	Reactive Power phase 3	var / 100
20775	5127	2	Apparent power phase 1	VA / 100
20777	5129	2	Apparent power phase 2	VA / 100
20779	512B	2	Apparent power phase 3	VA / 100
20781	512D	1	Power Factor phase 1 (-: leading and +: lagging)	% / 100
20782	512E	1	Power Factor phase 2 (-: leading and +: lagging)	% / 100
20783	512F	1	Power Factor phase 3 (-: leading and +: lagging)	% / 100
20784	5130	2	Total Active Power	W / 100
20786	5132	2	Total Reactive Power	var / 100
20788	5134	2	Total Apparent Power	VA / 100
20790	5136	1	Total Power Factor (-: leading and +: lagging)	% / 100

Up Stream Status				
20791	5137	1	Neutral position 0: Left 1: Right	
20792	5138	1	Source 1: Single voltage unbalance	% / 100
20793	5139	1	Source 1: Phases rotation 0: N/A 1: ABC 2: ACB	
20794	513A	1	Source 2: Single voltage unbalance	% / 100
20795	513B	1	Source 2: Phases rotation 0: N/A 1: ABC 2: ACB	

4.5.2.12. Energies and time meters

Function 3 Codes

Dec. Address	Hex. Address	Words count	Description	Unit
20992	5200	2	Date & Time current	sec.

Energies meters				
20994	5202	2	Total Positive Active Energy (Ea+) source 1	kWh
20996	5204	2	Total Positive Reactive Energy (Er+) source 1	kVARh
20998	5206	2	Total Apparent Energy (Es) source 1	kVAh
21000	5208	2	Total Negative Active Energy (Ea-) source 1	kWh
21002	520A	2	Total Negative Reactive Energy (Er-) source 1	kVARh
21004	520C	2	User Partial Positive Active Energy (Ea+) source 1	kWh
21006	520E	2	User Partial Positive Reactive Energy (Er+) source 1	kVARh

Energies meters				
21008	5210	2	User Partial Apparent Energy (Es) source 1	kVAh
21010	5212	2	User Partial Negative Active Energy (Ea-) source 1	kWh
21012	5214	2	User Partial Negative Reactive Energy (Er-) source 1	kVARh
21014	5216	2	Since Last Commutation Positive Active Energy (Ea+) source 1	kWh
21016	5218	2	Since Last Commutation Positive Reactive Energy (Er+) source 1	kVARh
21018	521A	2	Since Last Commutation Apparent Energy (Es) source 1	kVAh
21020	521C	2	Since Last Commutation Negative Active Energy (Ea-) source 1	kWh
21022	521E	2	Since Last Commutation Negative Reactive Energy (Er-) source 1	kVARh
21024	5220	2	Total Positive Active Energy (Ea+) source 2	kWh
21026	5222	2	Total Positive Reactive Energy (Er+) source 2	kVARh
21028	5224	2	Total Apparent Energy (Es) source 2	kVAh
21030	5226	2	Total Negative Active Energy (Ea-) source 2	kWh
21032	5228	2	Total Negative Reactive Energy (Er-) source 2	kVARh
21034	522A	2	User Partial Positive Active Energy (Ea+) source 2	kWh
21036	522C	2	User Partial Positive Reactive Energy (Er+) source 2	kVARh
21038	522E	2	User Partial Apparent Energy (Es) source 2	kVAh
21040	5230	2	User Partial Negative Active Energy (Ea-) source 2	kWh
21042	5232	2	User Partial Negative Reactive Energy (Er-) source 2	kVARh
21044	5234	2	Since Last Commutation Positive Active Energy (Ea+) source 2	kWh
21046	5236	2	Since Last Commutation Positive Reactive Energy (Er+) source 2	kVARh
21048	5238	2	Since Last Commutation Apparent Energy (Es) source 2	kVAh
21050	523A	2	Since Last Commutation Negative Active Energy (Ea-) source 2	kWh
21052	523C	2	Since Last Commutation Negative Reactive Energy (Er-) source 2	kVARh

Time meters				
21054	523E	2	Total time on source 1	sec.
21056	5240	2	User partial time on source 1	sec.
21058	5242	2	Since last commutation time on source 1	sec.
21060	5244	2	Total time on source 2	sec.
21062	5246	2	User partial time on source 2	sec.
21064	5248	2	Since last commutation time on source 2	sec.

4.5.2.13. Timers state

Function 3 Codes

Dec. Address	Hex. Address	Words count	Description	Unit
21248	5300	2	Date & Time Current	sec.
21250	5302	1	Source 1: SFT Timer / 1FT	sec.
21251	5303	1	Source 1: SAT Timer / 1RT	sec.
21253	5305	1	Source 2: SFT Timer / 2FT	sec.
21254	5306	1	Source 2: SAT Timer / 2RT Or 2AT	sec.
21255	5307	1	Source 2: LAT Timer / 2CT	sec.
21257	5309	1	Source 2: FST Timer / 2ST	sec.
21258	530A	1	DBT Timer / ODT	sec.
21259	530B	1	LoadShedding Timer (duration) / LST	sec.
21260	530C	1	TON is unlimited 0: limited 1: unlimited	

Dec. Address	Hex. Address	Words count	Description	Unit
21261	530D	1	TON (Test On Load Duration) Timer	sec.
21262	530E	1	T3T (Test on load end timer) Timer	sec.
21263	530F	1	TOF is unlimited <i>0: limited</i> <i>1: unlimited</i>	
21264	5310	1	TOF (Test Off Load Duration) Timer	sec.
21265	5311	1	STOLT (Time before Ord. Ext On Load) Timer / E1T	sec.
21266	5312	1	ETOLT (Time after Ord. Ext On Load) Timer / E3T	sec.
21267	5313	1	EOLTOT / E2T is unlimited <i>0: limited</i> <i>1: unlimited</i>	
21268	5314	1	EOLTOT (Ord. Ext On Load Duration) Timer / E2T	sec.
21269	5315	1	STOFT (Time before Ord. Ext Off Load) Timer / E5T	sec.
21270	5316	1	ETOFT (Time after Ord. Ext Off Load) Timer / E7T	sec.
21271	5317	1	EOFTOF / E6T is unlimited <i>0: limited</i> <i>1: unlimited</i>	
21272	5318	1	EOFTOF (Ord. Ext Off Load Duration) Timer / E6T	sec.
21273	5319	1	EET2: Secondary Source engine exerciser timeout / EET	hours
21274	531A	1	EDT2: Secondary Source engine exerciser duration / EDT	sec.
21275	531B	1	Source 1: SFT Timer / 1FT state <i>1: Active</i> <i>0: Not active</i>	
21276	531C	1	Source 1: SAT Timer / 1RT state <i>1: Active</i> <i>0: Not active</i>	
21277	531D	1	Source 1: ORT Timer / 1OT state <i>1: Active</i> <i>0: Not active</i>	
21278	531E	1	Source 2: SFT Timer / 2FT state <i>1: Active</i> <i>0: Not active</i>	
21279	531F	1	Source 2: SAT Timer / 2RT Or 2AT state <i>1: Active</i> <i>0: Not active</i>	
21280	5320	1	Source 2: LAT Timer / 2CT state <i>1: Active</i> <i>0: Not active</i>	
21281	5321	1	Source 2: ORT Timer / 2OT state <i>1: Active</i> <i>0: Not active</i>	
21282	5322	1	Source 2: FST Timer / 2ST state <i>1: Active</i> <i>0: Not active</i>	
21283	5323	1	DBT Timer / ODT state <i>1: Active</i> <i>0: Not active</i>	
21284	5324	1	LoadShedding Timer (duration) / LST state <i>1: Active</i> <i>0: Not active</i>	
21285	5325	1	TON (Test On Load Duration) Timer state <i>1: Active</i> <i>0: Not active</i>	
21286	5326	1	T3T (Test on load end timer) Timer state <i>1: Active</i> <i>0: Not active</i>	
21287	5327	1	TOF (Test Off Load Duration) Timer state <i>1: Active</i> <i>0: Not active</i>	

Dec. Address	Hex. Address	Words count	Description	Unit
21288	5328	1	STOLT (Time before Ord. Ext On Load) Timer / E1T state 1: Active 0: Not active	
21289	5329	1	ETOLT (Time after Ord. Ext On Load) Timer / E3T state 1: Active 0: Not active	
21290	532A	1	EOLTOT (Ord. Ext On Load Duration) Timer / E2T state 1: Active 0: Not active	
21291	532B	1	STOFT (Time before Ord. Ext Off Load) Timer / E5T state 1: Active 0: Not active	
21292	532C	1	ETOFT (Time after Ord. Ext Off Load) Timer / E7T state 1: Active 0: Not active	
21293	532D	1	EOFTOF (Ord. Ext Off Load Duration) Timer / E6T state 1: Active 0: Not active	
21294	532E	1	EET2: Secondary Source engine exerciser timeout / EET state 1: Active 0: Not active	
21295	532F	1	EDT2: Secondary Source engine exerciser duration / EDT state 1: Active 0: Not active	

4.5.2.14. Option module state

Function 3 Codes

Dec. Address	Hex. Address	Words count	Description	Unit
21504	5400	2	Date & Time Current	sec.
21506	5402	1	Option slot 1 Type 0xFF: None 0x00: Communication option 0x01: Metering option 0x20: Input/Output option 0x30: Analog Outputs option 0x70: Ethernet option	
21507	5403	1	Option slot 2 Type 0xFF: None 0x00: Communication option 0x01: Metering option 0x20: Input/Output option 0x30: Analog Outputs option 0x70: Ethernet option	
21508	5404	1	Option slot 3 Type 0xFF: None 0x00: Communication option 0x01: Metering option 0x20: Input/Output option 0x30: Analog Outputs option 0x70: Ethernet option	
21509	5405	1	Option slot 4 Type 0xFF: None 0x00: Communication option 0x01: Metering option 0x20: Input/Output option 0x30: Analog Outputs option 0x70: Ethernet option	

4.5.2.15. Commands

Function 6 Codes

Dec. Address	Hex. Address	Words count	Description	Unit
21760	5500	1	Set Command / Alarm <i>0x01: Set RTE</i> <i>0x02: Clear TOF</i> <i>0x03: Set TOF</i> <i>0x04: Set TON</i> <i>0x05: Set EOF</i> <i>0x06: Set EON</i> <i>0x07: Clear EOF</i> <i>0x08: Clear EON</i> <i>0x10: Clear Alarms/Faults</i> <i>0x11: Set External Fault 1</i> <i>0x12: Set External Fault 2</i> <i>0x13: Set External Alarm 1</i> <i>0x14: Set External Alarm 2</i>	
21761	5501	1	Set Operating Mode <i>3: Auto</i> <i>4: Inhibit</i> <i>5: Remote Control</i>	
21762	5502	1	Set Priority <i>0: Network</i> <i>1: Source 1</i> <i>2: Source 2</i>	
21763	5503	1	Set Position <i>0: None</i> <i>1: Position in Zero</i> <i>2: Position in 1</i> <i>3: Position in 2</i>	

4.5.2.16. User commands

Function 6 Codes

Dec. Address	Hex. Address	Words count	Description	Unit
21840	5550	1	Auto configuration request <i>1: make autoconfig</i>	
21841	5551	1	Settings backup <i>1: save current settings as user defaults</i> <i>2: restore user defaults settings</i> <i>3: restore factory settings</i>	
21842	5552	1	Source 1 partial counters erase <i>0x01: Ea+</i> <i>0x02: Er+</i> <i>0x04: Es</i> <i>0x08: Ea-</i> <i>0x10: Er-</i> <i>0x20: Hour counter</i>	
21843	5553	1	Source 2 partial counters erase <i>0x01: Ea+</i> <i>0x02: Er+</i> <i>0x04: Es</i> <i>0x08: Ea-</i> <i>0x10: Er-</i> <i>0x20: Hour counter</i>	
21844	5554	1	Product user counters erase <i>0x01: Genset start counter erase</i> <i>0x02: Genset runtime counter erase</i> <i>0x04: Secondary source presence counter erase</i> <i>0x08: Secondary source active duration counter erase</i> <i>0x10: Source 1 load supplied duration counter erase</i> <i>0x20: Source 2 load supplied duration counter erase</i>	

4.5.2.17. Setup timer

Function 3, 6 and 16 Codes

Dec. Address	Hex. Address	Words count	Description	Unit
Source 1 timers				
22016	5600	1	1FT: Primary Source fail timer	sec.
22017	5601	1	1RT: Primary Source availability/stabilization timer	sec.

Source 2 timers				
22023	5607	1	2FT: Secondary Source fail timer	sec.
22024	5608	1	2RT/2AT: Secondary Source availability/stabilization timer	sec.
22025	5609	1	2CT: Secondary Source maintain request timer (cooldown timer)	sec.
22027	560B	1	2ST: Secondary Source wait for start timer	sec.
22028	560C	1	EET: Secondary Source engine exerciser timeout	hours
22029	560D	1	EDT: Secondary Source engine exerciser duration	sec.

General timers				
22030	560E	1	ODT: Dead band timer	sec.
22031	560F	1	Limit_TON: Test on load is limited <i>0: unlimited</i> <i>1: limited</i>	
22032	5610	1	TOT: Test on load duration timer	sec.
22033	5611	1	T3T: Test on load end timer	sec.
22034	5612	1	Limit_TOF: Test off load is limited <i>0: unlimited</i> <i>1: limited</i>	
22035	5613	1	TFT: Test off load duration timer	sec.
22036	5614	1	E1T: Time before external order on load	sec.
22037	5615	1	E3T: Time after external order on load	sec.
22038	5616	1	Limit_EOLTOT: External order on load is limited <i>0: unlimited</i> <i>1: limited</i>	
22039	5617	1	E2T: External order on load duration	sec.
22040	5618	1	E5T: Time before external order off load	sec.
22041	5619	1	E7T: Time after external order off load	sec.
22042	561A	1	Limit_EOFTOF: External order off load is limited <i>0: unlimited</i> <i>1: limited</i>	
22043	561B	1	E7T: External order off load duration	sec.

Setup threshold for upstream Voltages

Function 3, 6 and 16 Codes

Dec. Address	Hex. Address	Words count	Description	Unit
22272	5700	1	Source 1: Overvoltage threshold	%
22273	5701	1	Source 1: Overvoltage hysteresis threshold	%
22274	5702	1	Source 1: Undervoltage threshold	%
22275	5703	1	Source 1: Undervoltage hysteresis threshold	%
22276	5704	1	Source 2: Overvoltage threshold	%
22277	5705	1	Source 2: Overvoltage hysteresis threshold	%
22278	5706	1	Source 2: Undervoltage threshold	%
22279	5707	1	Source 2: Undervoltage hysteresis threshold	%
22280	5708	1	Source 1: Unbalanced voltage threshold	%
22281	5709	1	Source 1: Unbalanced voltage hysteresis threshold	%
22282	570A	1	Source 2: Unbalanced voltage threshold	%
22283	570B	1	Source 2: Unbalanced voltage hysteresis threshold	%
22284	570C	1	Source 1: Overfrequency threshold	%
22285	570D	1	Source 1: Overfrequency hysteresis threshold	%
22286	570E	1	Source 1: Underfrequency threshold	%
22287	570F	1	Source 1: Underfrequency hysteresis threshold	%
22288	5710	1	Source 2: Overfrequency threshold	%
22289	5711	1	Source 2: Overfrequency hysteresis threshold	%
22290	5712	1	Source 2: Underfrequency threshold	%
22291	5713	1	Source 2: Underfrequency hysteresis threshold	%

4.5.2.18. Setup user's power threshold

Function 3, 6 and 16 Codes

Dec. Address	Hex. Address	Words count	Description	Unit
Source 1 user thresholds				
22528	5800	1	Source 1: Total Apparent Power threshold	kVA
22529	5801	1	Source 1: Total Apparent Power hysteresis threshold	kVA
Source 2 user thresholds				
22530	5802	1	Source 2: Total Apparent Power threshold	kVA
22531	5803	1	Source 2: Total Apparent Power hysteresis threshold	kVA

4.5.2.19. Setup network

Function 3, 6 and 16 Codes

Dec. Address	Hex. Address	Words count	Description	Unit
22784	5900	1	Network Type 0: 1BL 1: 2NBL 2: 2BL 3: 3NBL 4: 3BL 5: 4NBL 6: 4BL 7: 41NBL 8: 42NBL	

Dec. Address	Hex. Address	Words count	Description	Unit
22785	5901	1	Neutral 0: LEFT 1: RIGHT 2: AUTO	
22786	5902	1	Phase rotation 0: Verify Compatible ("Auto") 1: Verify ABC 2: Verify ACB	
22787	5903	1	Unom	V
22788	5904	1	Fnom 0: 50Hz 1: 60Hz	
22789	5905	1	Type Application 0: Main - Main 1: Main - Gen	
22790	5906	1	Generator start order inhibit 0: NO 1: YES	
22792	5908	1	Source priority 0: Network 1: Source1 2: Source2	
22793	5909	1	Test On Load priority 0: NO 1: YES	
22794	590A	1	External Order On Load priority 0: NO 1: YES	
22795	590B	1	Manual retransfer 0: NO 1: YES	
22799	590F	1	BackLight 0: ON 1: OFF 2: INT	
22800	5910	1	Current transformer (Pri)	-
22801	5911	1	Current transformer (Sec) 1: TCsec = 1A 5: TCsec = 2A	
22802	5912	1	Invert Source 1 and Source 2 0: Not inverted 1: Inverted	

4.5.2.20. Setup Input/Output

Function 3, 6 and 16 Codes

Dec. Address	Hex. Address	Words count	Description	Unit
23040	5A00	1	In 5 - StartGen board input 1 function 0: --- - None 1: INH - Inhibition 2: TON - Test on load 3: TOF - Test off load 4: EON - External order on load 5: EOF - External order off load 6: RTC - Retransfer 7: PRI - Priority 8: SS1 - Validation Stabilization source 1 9: SS2 - Validation Stabilization source 2 10: AL1 - Alarm 1 11: AL2 - Alarm 2 12: FT1 - Fault 1 13: FT2 - Fault 2 14: MSR - Power priority 15: OA1 - Override source 1 available 16: OA2 - Override source 2 available 17: RST - Reset faults state 18: LSI - Load shedding 19: TR1 - Time Range1 Validate 20: TR2 - Time Range2 Validate 21: TR3 - Time Range3 Validate 22: TR4 - Time Range4 Validate	
23041	5A01	1	In 6 - StartGen board input 2 function 0: --- - None 1: INH - Inhibition 2: TON - Test on load 3: TOF - Test off load 4: EON - External order on load 5: EOF - External order off load 6: RTC - Retransfer 7: PRI - Priority 8: SS1 - Validation Stabilization source 1 9: SS2 - Validation Stabilization source 2 10: AL1 - Alarm 1 11: AL2 - Alarm 2 12: FT1 - Fault 1 13: FT2 - Fault 2 14: MSR - Power priority 15: OA1 - Override source 1 available 16: OA2 - Override source 2 available 17: RST - Reset faults state 18: LSI - Load shedding 19: TR1 - Time Range1 Validate 20: TR2 - Time Range2 Validate 21: TR3 - Time Range3 Validate 22: TR4 - Time Range4 Validate	
23042	5A02	1	In 5 - Input n°5 state 0: NO 1: NC	
23043	5A03	1	In 6 - Input n°6 state 0: NO 1: NC	

Dec. Address	Hex. Address	Words count	Description	Unit
23044	5A04	1	<p>In 1 - Ext display connector board input 1 function</p> <p>0: --- - None</p> <p>1: INH - Inhibition</p> <p>2: TON - Test on load</p> <p>3: TOF - Test off load</p> <p>4: EON - External order on load</p> <p>5: EOF - External order off load</p> <p>6: RTC - Retransfer</p> <p>7: PRI - Priority</p> <p>8: SS1 - Validation Stabilization source 1</p> <p>9: SS2 - Validation Stabilization source 2</p> <p>10: AL1 - Alarm 1</p> <p>11: AL2 - Alarm 2</p> <p>12: FT1 - Fault 1</p> <p>13: FT2 - Fault 2</p> <p>14: MSR - Power priority</p> <p>15: OA1 - Override source 1 available</p> <p>16: OA2 - Override source 2 available</p> <p>17: RST - Reset faults state</p> <p>18: LSI - Load shedding</p> <p>19: TR1 - Time Range1 Validate</p> <p>20: TR2 - Time Range2 Validate</p> <p>21: TR3 - Time Range3 Validate</p> <p>22: TR4 - Time Range4 Validate</p>	
23045	5A05	1	<p>In 2 - Ext display connector board input 2 function</p> <p>0: --- - None</p> <p>1: INH - Inhibition</p> <p>2: TON - Test on load</p> <p>3: TOF - Test off load</p> <p>4: EON - External order on load</p> <p>5: EOF - External order off load</p> <p>6: RTC - Retransfer</p> <p>7: PRI - Priority</p> <p>8: SS1 - Validation Stabilization source 1</p> <p>9: SS2 - Validation Stabilization source 2</p> <p>10: AL1 - Alarm 1</p> <p>11: AL2 - Alarm 2</p> <p>12: FT1 - Fault 1</p> <p>13: FT2 - Fault 2</p> <p>14: MSR - Power priority</p> <p>15: OA1 - Override source 1 available</p> <p>16: OA2 - Override source 2 available</p> <p>17: RST - Reset faults state</p> <p>18: LSI - Load shedding</p> <p>19: TR1 - Time Range1 Validate</p> <p>20: TR2 - Time Range2 Validate</p> <p>21: TR3 - Time Range3 Validate</p> <p>22: TR4 - Time Range4 Validate</p>	
23046	5A06	1	<p>In 3 - Ext display connector board input 3 function</p> <p>0: --- - None</p> <p>1: INH - Inhibition</p> <p>2: TON - Test on load</p> <p>3: TOF - Test off load</p> <p>4: EON - External order on load</p> <p>5: EOF - External order off load</p> <p>6: RTC - Retransfer</p> <p>7: PRI - Priority</p> <p>8: SS1 - Validation Stabilization source 1</p> <p>9: SS2 - Validation Stabilization source 2</p> <p>10: AL1 - Alarm 1</p> <p>11: AL2 - Alarm 2</p> <p>12: FT1 - Fault 1</p> <p>13: FT2 - Fault 2</p> <p>14: MSR - Power priority</p> <p>15: OA1 - Override source 1 available</p> <p>16: OA2 - Override source 2 available</p> <p>17: RST - Reset faults state</p> <p>18: LSI - Load shedding</p> <p>19: TR1 - Time Range1 Validate</p> <p>20: TR2 - Time Range2 Validate</p> <p>21: TR3 - Time Range3 Validate</p> <p>22: TR4 - Time Range4 Validate</p>	

Dec. Address	Hex. Address	Words count	Description	Unit
23047	5A07	1	In 4 - Ext display connector board input 4 function 0: --- - None 1: INH - Inhibition 2: TON - Test on load 3: TOF - Test off load 4: EON - External order on load 5: EOF - External order off load 6: RTC - Retransfer 7: PRI - Priority 8: SS1 - Validation Stabilization source 1 9: SS2 - Validation Stabilization source 2 10: AL1 - Alarm 1 11: AL2 - Alarm 2 12: FT1 - Fault 1 13: FT2 - Fault 2 14: MSR - Power priority 15: OA1 - Override source 1 available 16: OA2 - Override source 2 available 17: RST - Reset faults state 18: LSI - Load shedding 19: TR1 - Time Range1 Validate 20: TR2 - Time Range2 Validate 21: TR3 - Time Range3 Validate 22: TR4 - Time Range4 Validate	
23048	5A08	1	In 1 - Input n°1 state 0: NO 1: NC	
23049	5A09	1	In 2 - Input n°2 state 0: NO 1: NC	
23050	5A0A	1	In 3 - Input n°3 state 0: NO 1: NC	
23051	5A0B	1	In 4 - Input n°4 state 0: NO 1: NC	
23052	5A0C	1	In 7 function (only with 2IN2OUT module #1) 0: --- - None 1: INH - Inhibition 2: TON - Test on load 3: TOF - Test off load 4: EON - External order on load 5: EOF - External order off load 6: RTC - Retransfer 7: PRI - Priority 8: SS1 - Validation Stabilization source 1 9: SS2 - Validation Stabilization source 2 10: AL1 - Alarm 1 11: AL2 - Alarm 2 12: FT1 - Fault 1 13: FT2 - Fault 2 14: MSR - Power priority 15: OA1 - Override source 1 available 16: OA2 - Override source 2 available 17: RST - Reset faults state 18: LSI - Load shedding 19: TR1 - Time Range1 Validate 20: TR2 - Time Range2 Validate 21: TR3 - Time Range3 Validate 22: TR4 - Time Range4 Validate	

Dec. Address	Hex. Address	Words count	Description	Unit
23053	5A0D	1	<p>In 8 function (only with 2IN2OUT module #1)</p> <p>0: --- - None</p> <p>1: INH - Inhibition</p> <p>2: TON - Test on load</p> <p>3: TOF - Test off load</p> <p>4: EON - External order on load</p> <p>5: EOF - External order off load</p> <p>6: RTC - Retransfer</p> <p>7: PRI - Priority</p> <p>8: SS1 - Validation Stabilization source 1</p> <p>9: SS2 - Validation Stabilization source 2</p> <p>10: AL1 - Alarm 1</p> <p>11: AL2 - Alarm 2</p> <p>12: FT1 - Fault 1</p> <p>13: FT2 - Fault 2</p> <p>14: MSR - Power priority</p> <p>15: OA1 - Override source 1 available</p> <p>16: OA2 - Override source 2 available</p> <p>17: RST - Reset faults state</p> <p>18: LSI - Load shedding</p> <p>19: TR1 - Time Range1 Validate</p> <p>20: TR2 - Time Range2 Validate</p> <p>21: TR3 - Time Range3 Validate</p> <p>22: TR4 - Time Range4 Validate</p>	
23054	5A0E	1	<p>In 9 function (only with 2IN2OUT module #2)</p> <p>0: --- - None</p> <p>1: INH - Inhibition</p> <p>2: TON - Test on load</p> <p>3: TOF - Test off load</p> <p>4: EON - External order on load</p> <p>5: EOF - External order off load</p> <p>6: RTC - Retransfer</p> <p>7: PRI - Priority</p> <p>8: SS1 - Validation Stabilization source 1</p> <p>9: SS2 - Validation Stabilization source 2</p> <p>10: AL1 - Alarm 1</p> <p>11: AL2 - Alarm 2</p> <p>12: FT1 - Fault 1</p> <p>13: FT2 - Fault 2</p> <p>14: MSR - Power priority</p> <p>15: OA1 - Override source 1 available</p> <p>16: OA2 - Override source 2 available</p> <p>17: RST - Reset faults state</p> <p>18: LSI - Load shedding</p> <p>19: TR1 - Time Range1 Validate</p> <p>20: TR2 - Time Range2 Validate</p> <p>21: TR3 - Time Range3 Validate</p> <p>22: TR4 - Time Range4 Validate</p>	
23055	5A0F	1	<p>In 10 function (only with 2IN2OUT module #2)</p> <p>0: --- - None</p> <p>1: INH - Inhibition</p> <p>2: TON - Test on load</p> <p>3: TOF - Test off load</p> <p>4: EON - External order on load</p> <p>5: EOF - External order off load</p> <p>6: RTC - Retransfer</p> <p>7: PRI - Priority</p> <p>8: SS1 - Validation Stabilization source 1</p> <p>9: SS2 - Validation Stabilization source 2</p> <p>10: AL1 - Alarm 1</p> <p>11: AL2 - Alarm 2</p> <p>12: FT1 - Fault 1</p> <p>13: FT2 - Fault 2</p> <p>14: MSR - Power priority</p> <p>15: OA1 - Override source 1 available</p> <p>16: OA2 - Override source 2 available</p> <p>17: RST - Reset faults state</p> <p>18: LSI - Load shedding</p> <p>19: TR1 - Time Range1 Validate</p> <p>20: TR2 - Time Range2 Validate</p> <p>21: TR3 - Time Range3 Validate</p> <p>22: TR4 - Time Range4 Validate</p>	

Dec. Address	Hex. Address	Words count	Description	Unit
23056	5A10	1	<p>In 11 function (only with 2IN2OUT module #3)</p> <p>0: --- - None 1: INH - Inhibition 2: TON - Test on load 3: TOF - Test off load 4: EON - External order on load 5: EOF - External order off load 6: RTC - Retransfer 7: PRI - Priority 8: SS1 - Validation Stabilization source 1 9: SS2 - Validation Stabilization source 2 10: AL1 - Alarm 1 11: AL2 - Alarm 2 12: FT1 - Fault 1 13: FT2 - Fault 2 14: MSR - Power priority 15: OA1 - Override source 1 available 16: OA2 - Override source 2 available 17: RST - Reset faults state 18: LSI - Load shedding 19: TR1 - Time Range1 Validate 20: TR2 - Time Range2 Validate 21: TR3 - Time Range3 Validate 22: TR4 - Time Range4 Validate</p>	
23057	5A11	1	<p>In 12 function (only with 2IN2OUT module #3)</p> <p>0: --- - None 1: INH - Inhibition 2: TON - Test on load 3: TOF - Test off load 4: EON - External order on load 5: EOF - External order off load 6: RTC - Retransfer 7: PRI - Priority 8: SS1 - Validation Stabilization source 1 9: SS2 - Validation Stabilization source 2 10: AL1 - Alarm 1 11: AL2 - Alarm 2 12: FT1 - Fault 1 13: FT2 - Fault 2 14: MSR - Power priority 15: OA1 - Override source 1 available 16: OA2 - Override source 2 available 17: RST - Reset faults state 18: LSI - Load shedding 19: TR1 - Time Range1 Validate 20: TR2 - Time Range2 Validate 21: TR3 - Time Range3 Validate 22: TR4 - Time Range4 Validate</p>	

Dec. Address	Hex. Address	Words count	Description	Unit
23058	5A12	1	In 13 function (only with 2IN2OUT module #4) 0: --- - None 1: INH - Inhibition 2: TON - Test on load 3: TOF - Test off load 4: EON - External order on load 5: EOF - External order off load 6: RTC - Retransfer 7: PRI - Priority 8: SS1 - Validation Stabilization source 1 9: SS2 - Validation Stabilization source 2 10: AL1 - Alarm 1 11: AL2 - Alarm 2 12: FT1 - Fault 1 13: FT2 - Fault 2 14: MSR - Power priority 15: OA1 - Override source 1 available 16: OA2 - Override source 2 available 17: RST - Reset faults state 18: LSI - Load shedding 19: TR1 - Time Range1 Validate 20: TR2 - Time Range2 Validate 21: TR3 - Time Range3 Validate 22: TR4 - Time Range4 Validate	
23059	5A13	1	In 14 function (only with 2IN2OUT module #4) 0: --- - None 1: INH - Inhibition 2: TON - Test on load 3: TOF - Test off load 4: EON - External order on load 5: EOF - External order off load 6: RTC - Retransfer 7: PRI - Priority 8: SS1 - Validation Stabilization source 1 9: SS2 - Validation Stabilization source 2 10: AL1 - Alarm 1 11: AL2 - Alarm 2 12: FT1 - Fault 1 13: FT2 - Fault 2 14: MSR - Power priority 15: OA1 - Override source 1 available 16: OA2 - Override source 2 available 17: RST - Reset faults state 18: LSI - Load shedding 19: TR1 - Time Range1 Validate 20: TR2 - Time Range2 Validate 21: TR3 - Time Range3 Validate 22: TR4 - Time Range4 Validate	
23060	5A14	1	In 7 state (only with 2IN2OUT module #1) 0: NO 1: NC	
23061	5A15	1	In 8 state (only with 2IN2OUT module #1) 0: NO 1: NC	
23062	5A16	1	In 9 state (only with 2IN2OUT module #2) 0: NO 1: NC	
23063	5A17	1	In 10 state (only with 2IN2OUT module #2) 0: NO 1: NC	
23064	5A18	1	In 11 state (only with 2IN2OUT module #3) 0: NO 1: NC	

Dec. Address	Hex. Address	Words count	Description	Unit
23065	5A19	1	In 12 state (only with 2IN2OUT module #3) 0: NO 1: NC	
23066	5A1A	1	In 13 state (only with 2IN2OUT module #4) 0: NO 1: NC	
23067	5A1B	1	In 14 state (only with 2IN2OUT module #4) 0: NO 1: NC	
23068	5A1C	1	Out 1 Ext display connector board relay output function 0: --- - None 1: S1A - Source 1 available 2: S2A - Source 2 available 3: SCA - Any source available 4: CA1 - Source 1 closed 5: CA2 - Source 2 closed 6: CA0 - Both sources opened 7: LO1 - Source 1 closed and available 8: LO2 - Source 2 closed and available 9: LSC - Load shedding 10: FLT - Faults active 11: POP - Product operational 12: C01 - In 1 copy 13: C02 - In 2 copy 14: C03 - In 3 copy 15: C04 - In 4 copy 16: C05 - In 5 copy 17: C06 - In 6 copy 18: C07 - In 7 copy 19: C08 - In 8 copy 20: C09 - In 9 copy 21: C10 - In 10 copy 22: C11 - In 11 copy 23: C12 - In 12 copy 24: C13 - In 13 copy 25: C14 - In 14 copy 26: LCK - Product locked 27: PTS - Power threshold exceeded 28: EES - Battery charger 29: COM - Set by Modbus	
23069	5A1D	1	Out 1 Ext display connector board relay output state 0: NO 1: NC	

Dec. Address	Hex. Address	Words count	Description	Unit
23070	5A1E	1	<p>Out 2 function (only with 2IN2OUT module #1)</p> <p>0: --- - None</p> <p>1: S1A - Source 1 available</p> <p>2: S2A - Source 2 available</p> <p>3: SCA - Any source available</p> <p>4: CA1 - Source 1 closed</p> <p>5: CA2 - Source 2 closed</p> <p>6: CA0 - Both sources opened</p> <p>7: LO1 - Source 1 closed and available</p> <p>8: LO2 - Source 2 closed and available</p> <p>9: LSC - Load shedding</p> <p>10: FLT - Faults active</p> <p>11: POP - Product operational</p> <p>12: C01 - In 1 copy</p> <p>13: C02 - In 2 copy</p> <p>14: C03 - In 3 copy</p> <p>15: C04 - In 4 copy</p> <p>16: C05 - In 5 copy</p> <p>17: C06 - In 6 copy</p> <p>18: C07 - In 7 copy</p> <p>19: C08 - In 8 copy</p> <p>20: C09 - In 9 copy</p> <p>21: C10 - In 10 copy</p> <p>22: C11 - In 11 copy</p> <p>23: C12 - In 12 copy</p> <p>24: C13 - In 13 copy</p> <p>25: C14 - In 14 copy</p> <p>26: LCK - Product locked</p> <p>27: PTS - Power threshold exceeded</p> <p>28: EES - Battery charger</p> <p>29: COM - Set by Modbus</p>	
23071	5A1F	1	<p>Out 3 function (only with 2IN2OUT module #1)</p> <p>0: --- - None</p> <p>1: S1A - Source 1 available</p> <p>2: S2A - Source 2 available</p> <p>3: SCA - Any source available</p> <p>4: CA1 - Source 1 closed</p> <p>5: CA2 - Source 2 closed</p> <p>6: CA0 - Both sources opened</p> <p>7: LO1 - Source 1 closed and available</p> <p>8: LO2 - Source 2 closed and available</p> <p>9: LSC - Load shedding</p> <p>10: FLT - Faults active</p> <p>11: POP - Product operational</p> <p>12: C01 - In 1 copy</p> <p>13: C02 - In 2 copy</p> <p>14: C03 - In 3 copy</p> <p>15: C04 - In 4 copy</p> <p>16: C05 - In 5 copy</p> <p>17: C06 - In 6 copy</p> <p>18: C07 - In 7 copy</p> <p>19: C08 - In 8 copy</p> <p>20: C09 - In 9 copy</p> <p>21: C10 - In 10 copy</p> <p>22: C11 - In 11 copy</p> <p>23: C12 - In 12 copy</p> <p>24: C13 - In 13 copy</p> <p>25: C14 - In 14 copy</p> <p>26: LCK - Product locked</p> <p>27: PTS - Power threshold exceeded</p> <p>28: EES - Battery charger</p> <p>29: COM - Set by Modbus</p>	

Dec. Address	Hex. Address	Words count	Description	Unit
23072	5A20	1	<p>Out 4 function (only with 2IN2OUT module #2)</p> <p>0: --- - None</p> <p>1: S1A - Source 1 available</p> <p>2: S2A - Source 2 available</p> <p>3: SCA - Any source available</p> <p>4: CA1 - Source 1 closed</p> <p>5: CA2 - Source 2 closed</p> <p>6: CA0 - Both sources opened</p> <p>7: LO1 - Source 1 closed and available</p> <p>8: LO2 - Source 2 closed and available</p> <p>9: LSC - Load shedding</p> <p>10: FLT - Faults active</p> <p>11: POP - Product operational</p> <p>12: C01 - In 1 copy</p> <p>13: C02 - In 2 copy</p> <p>14: C03 - In 3 copy</p> <p>15: C04 - In 4 copy</p> <p>16: C05 - In 5 copy</p> <p>17: C06 - In 6 copy</p> <p>18: C07 - In 7 copy</p> <p>19: C08 - In 8 copy</p> <p>20: C09 - In 9 copy</p> <p>21: C10 - In 10 copy</p> <p>22: C11 - In 11 copy</p> <p>23: C12 - In 12 copy</p> <p>24: C13 - In 13 copy</p> <p>25: C14 - In 14 copy</p> <p>26: LCK - Product locked</p> <p>27: PTS - Power threshold exceeded</p> <p>28: EES - Battery charger</p> <p>29: COM - Set by Modbus</p>	
23073	5A21	1	<p>Out 5 function (only with 2IN2OUT module #2)</p> <p>0: --- - None</p> <p>1: S1A - Source 1 available</p> <p>2: S2A - Source 2 available</p> <p>3: SCA - Any source available</p> <p>4: CA1 - Source 1 closed</p> <p>5: CA2 - Source 2 closed</p> <p>6: CA0 - Both sources opened</p> <p>7: LO1 - Source 1 closed and available</p> <p>8: LO2 - Source 2 closed and available</p> <p>9: LSC - Load shedding</p> <p>10: FLT - Faults active</p> <p>11: POP - Product operational</p> <p>12: C01 - In 1 copy</p> <p>13: C02 - In 2 copy</p> <p>14: C03 - In 3 copy</p> <p>15: C04 - In 4 copy</p> <p>16: C05 - In 5 copy</p> <p>17: C06 - In 6 copy</p> <p>18: C07 - In 7 copy</p> <p>19: C08 - In 8 copy</p> <p>20: C09 - In 9 copy</p> <p>21: C10 - In 10 copy</p> <p>22: C11 - In 11 copy</p> <p>23: C12 - In 12 copy</p> <p>24: C13 - In 13 copy</p> <p>25: C14 - In 14 copy</p> <p>26: LCK - Product locked</p> <p>27: PTS - Power threshold exceeded</p> <p>28: EES - Battery charger</p> <p>29: COM - Set by Modbus</p>	

Dec. Address	Hex. Address	Words count	Description	Unit
23074	5A22	1	<p>Out 6 function (only with 2IN2OUT module #3)</p> <p>0: --- - None</p> <p>1: S1A - Source 1 available</p> <p>2: S2A - Source 2 available</p> <p>3: SCA - Any source available</p> <p>4: CA1 - Source 1 closed</p> <p>5: CA2 - Source 2 closed</p> <p>6: CA0 - Both sources opened</p> <p>7: LO1 - Source 1 closed and available</p> <p>8: LO2 - Source 2 closed and available</p> <p>9: LSC - Load shedding</p> <p>10: FLT - Faults active</p> <p>11: POP - Product operational</p> <p>12: C01 - In 1 copy</p> <p>13: C02 - In 2 copy</p> <p>14: C03 - In 3 copy</p> <p>15: C04 - In 4 copy</p> <p>16: C05 - In 5 copy</p> <p>17: C06 - In 6 copy</p> <p>18: C07 - In 7 copy</p> <p>19: C08 - In 8 copy</p> <p>20: C09 - In 9 copy</p> <p>21: C10 - In 10 copy</p> <p>22: C11 - In 11 copy</p> <p>23: C12 - In 12 copy</p> <p>24: C13 - In 13 copy</p> <p>25: C14 - In 14 copy</p> <p>26: LCK - Product locked</p> <p>27: PTS - Power threshold exceeded</p> <p>28: EES - Battery charger</p> <p>29: COM - Set by Modbus</p>	
23075	5A23	1	<p>Out 7 function (only with 2IN2OUT module #3)</p> <p>0: --- - None</p> <p>1: S1A - Source 1 available</p> <p>2: S2A - Source 2 available</p> <p>3: SCA - Any source available</p> <p>4: CA1 - Source 1 closed</p> <p>5: CA2 - Source 2 closed</p> <p>6: CA0 - Both sources opened</p> <p>7: LO1 - Source 1 closed and available</p> <p>8: LO2 - Source 2 closed and available</p> <p>9: LSC - Load shedding</p> <p>10: FLT - Faults active</p> <p>11: POP - Product operational</p> <p>12: C01 - In 1 copy</p> <p>13: C02 - In 2 copy</p> <p>14: C03 - In 3 copy</p> <p>15: C04 - In 4 copy</p> <p>16: C05 - In 5 copy</p> <p>17: C06 - In 6 copy</p> <p>18: C07 - In 7 copy</p> <p>19: C08 - In 8 copy</p> <p>20: C09 - In 9 copy</p> <p>21: C10 - In 10 copy</p> <p>22: C11 - In 11 copy</p> <p>23: C12 - In 12 copy</p> <p>24: C13 - In 13 copy</p> <p>25: C14 - In 14 copy</p> <p>26: LCK - Product locked</p> <p>27: PTS - Power threshold exceeded</p> <p>28: EES - Battery charger</p> <p>29: COM - Set by Modbus</p>	

Dec. Address	Hex. Address	Words count	Description	Unit
23076	5A24	1	<p>Out 8 function (only with 2IN2OUT module #4)</p> <p>0: --- - None</p> <p>1: S1A - Source 1 available</p> <p>2: S2A - Source 2 available</p> <p>3: SCA - Any source available</p> <p>4: CA1 - Source 1 closed</p> <p>5: CA2 - Source 2 closed</p> <p>6: CA0 - Both sources opened</p> <p>7: LO1 - Source 1 closed and available</p> <p>8: LO2 - Source 2 closed and available</p> <p>9: LSC - Load shedding</p> <p>10: FLT - Faults active</p> <p>11: POP - Product operational</p> <p>12: C01 - In 1 copy</p> <p>13: C02 - In 2 copy</p> <p>14: C03 - In 3 copy</p> <p>15: C04 - In 4 copy</p> <p>16: C05 - In 5 copy</p> <p>17: C06 - In 6 copy</p> <p>18: C07 - In 7 copy</p> <p>19: C08 - In 8 copy</p> <p>20: C09 - In 9 copy</p> <p>21: C10 - In 10 copy</p> <p>22: C11 - In 11 copy</p> <p>23: C12 - In 12 copy</p> <p>24: C13 - In 13 copy</p> <p>25: C14 - In 14 copy</p> <p>26: LCK - Product locked</p> <p>27: PTS - Power threshold exceeded</p> <p>28: EES - Battery charger</p> <p>29: COM - Set by Modbus</p>	
23077	5A25	1	<p>Out 9 function (only with 2IN2OUT module #4)</p> <p>0: --- - None</p> <p>1: S1A - Source 1 available</p> <p>2: S2A - Source 2 available</p> <p>3: SCA - Any source available</p> <p>4: CA1 - Source 1 closed</p> <p>5: CA2 - Source 2 closed</p> <p>6: CA0 - Both sources opened</p> <p>7: LO1 - Source 1 closed and available</p> <p>8: LO2 - Source 2 closed and available</p> <p>9: LSC - Load shedding</p> <p>10: FLT - Faults active</p> <p>11: POP - Product operational</p> <p>12: C01 - In 1 copy</p> <p>13: C02 - In 2 copy</p> <p>14: C03 - In 3 copy</p> <p>15: C04 - In 4 copy</p> <p>16: C05 - In 5 copy</p> <p>17: C06 - In 6 copy</p> <p>18: C07 - In 7 copy</p> <p>19: C08 - In 8 copy</p> <p>20: C09 - In 9 copy</p> <p>21: C10 - In 10 copy</p> <p>22: C11 - In 11 copy</p> <p>23: C12 - In 12 copy</p> <p>24: C13 - In 13 copy</p> <p>25: C14 - In 14 copy</p> <p>26: LCK - Product locked</p> <p>27: PTS - Power threshold exceeded</p> <p>28: EES - Battery charger</p> <p>29: COM - Set by Modbus</p>	
23078	5A26	1	<p>Out 2 state (only with 2IN2OUT module #1)</p> <p>0: NO</p> <p>1: NC</p>	
23079	5A27	1	<p>Out 3 state (only with 2IN2OUT module #1)</p> <p>0: NO</p> <p>1: NC</p>	

Dec. Address	Hex. Address	Words count	Description	Unit
23080	5A28	1	Out 4 state (only with 2IN2OUT module #2) 0: NO 1: NC	
23081	5A29	1	Out 5 state (only with 2IN2OUT module #2) 0: NO 1: NC	
23082	5A2A	1	Out 6 state (only with 2IN2OUT module #3) 0: NO 1: NC	
23083	5A2B	1	Out 7 state (only with 2IN2OUT module #3) 0: NO 1: NC	
23084	5A2C	1	Out 8 state (only with 2IN2OUT module #4) 0: NO 1: NC	
23085	5A2D	1	Out 9 state (only with 2IN2OUT module #4) 0: NO 1: NC	

4.5.2.21. Communication settings

Function 3, 6 and 16 Codes

Dec. Address	Hex. Address	Words count	Description	Unit
23296	5B00	1	MODBUS Address	-
23297	5B01	1	UART Baud Rate 2: 9600 bps 3: 19200 bps 4: 38400 bps	
23298	5B02	1	UART Parity 0: none 1: even 2: odd	
23299	5B03	1	UART Stop bit number 1: 1 stop bit 2: 2 stop bits	
23300	5B04	2	IP Product	-
23302	5B06	2	IP Mask	-
23304	5B08	2	IP Gateway	-
23306	5B0A	1	DHCP Enabled 0: No 1: Yes	
23307	5B0B	8	Product identification	-

4.5.2.22. Product counters

Function 3 Codes

Dec. Address	Hex. Address	Words count	Description	Unit
23552	5C00	1	Total Cycles counter	nb of cycles
23553	5C01	1	Total Position 0 switches counter	nb of operations
23554	5C02	1	Total Position I switches counter	nb of operations
23555	5C03	1	Total Position II switches counter	nb of operations
23556	5C04	1	Total switches counter	nb of operations
23557	5C05	1	Cycles in auto mode (including control mode) counter	nb of cycles
23558	5C06	1	Position 0 switches in auto mode (including control mode) counter	nb of operations
23559	5C07	1	Position I switches in auto mode (including control mode) counter	nb of operations
23560	5C08	1	Position II switches in auto mode (including control mode) counter	nb of operations
23561	5C09	1	Total switches in auto mode (including control mode) counter	nb of operations
23562	5C0A	1	Cycles in manual mode counter	nb of cycles
23563	5C0B	1	Position 0 switches in manual mode counter	nb of operations
23564	5C0C	1	Position I switches in manual mode counter	nb of operations
23565	5C0D	1	Position II switches in manual mode counter	nb of operations
23566	5C0E	1	Total switches in manual mode counter	nb of operations
23567	5C0F	1	Cycles in control mode counter	nb of cycles
23568	5C10	1	Position 0 switches in control mode counter	nb of operations
23569	5C11	1	Position I switches in control mode counter	nb of operations
23570	5C12	1	Position II switches in control mode counter	nb of operations
23571	5C13	1	Total switches in control mode counter	nb of operations
23572	5C14	2	Product power on time	s
23574	5C16	1	Start order activation counter	nb of operations
23575	5C17	2	Start order active duration	s
23577	5C19	2	Secondary source presence duration	s
23579	5C1B	2	Secondary source active (i.e. present and switch position at secondary source) duration	s
23581	5C1D	2	Source 1 load supplied duration	s
23583	5C1F	2	Source 2 load supplied duration	s

4.5.2.23. Output set

Function 3, 6 and 16 Codes

Dec. Address	Hex. Address	Words count	Description	Unit
23632	5C50	1	OUT1 - Option Module1 Output1 logical state <i>0: Not active</i> <i>1: Active</i>	
23633	5C51	1	OUT2 - Option Module1 Output2 logical state <i>0: Not active</i> <i>1: Active</i>	
23634	5C52	1	OUT3 - Option Module2 Output1 logical state <i>0: Not active</i> <i>1: Active</i>	
23635	5C53	1	OUT4 - Option Module2 Output2 logical state <i>0: Not active</i> <i>1: Active</i>	

Dec. Address	Hex. Address	Words count	Description	Unit
23636	5C54	1	OUT5 - Option Module3 Output1 logical state 0: Not active 1: Active	
23637	5C55	1	OUT6 - Option Module3 Output2 logical state 0: Not active 1: Active	
23638	5C56	1	OUT7 - Option Module4 Output1 logical state 0: Not active 1: Active	
23639	5C57	1	OUT8 - Option Module4 Output2 logical state 0: Not active 1: Active	
23640	5C58	1	OP1 - External Board Output logical state 0: Not active 1: Active	
23641	5C59	1	Pulse Output1 logical state 0: Not active 1: Active	
23642	5C5A	1	Pulse Output2 logical state 0: Not active 1: Active	

4.5.2.24. Input state

Function 3 Codes

Dec. Address	Hex. Address	Words count	Description	Unit
23808	5D00	1	In 7 - Option Module1 Input1 logical state 0: Not active 1: Active	
23809	5D01	1	In 8 - Option Module1 Input2 logical state 0: Not active 1: Active	
23810	5D02	1	In 9 - Option Module2 Input1 logical state 0: Not active 1: Active	
23811	5D03	1	In 10 - Option Module2 Input2 logical state 0: Not active 1: Active	
23812	5D04	1	In 11 - Option Module3 Input1 logical state 0: Not active 1: Active	
23813	5D05	1	In 12 - Option Module3 Input2 logical state 0: Not active 1: Active	
23814	5D06	1	In 13 - Option Module4 Input1 logical state 0: Not active 1: Active	
23815	5D07	1	In 14 - Option Module4 Input2 logical state 0: Not active 1: Active	
23816	5D08	1	In 5 - STO Board Input1 logical state 0: Not active 1: Active	
23817	5D09	1	In 6 - STO Board Input2 logical state 0: Not active 1: Active	
23818	5D0A	1	In 1 - External Display Board Input1 logical state 0: Not active 1: Active	

Dec. Address	Hex. Address	Words count	Description	Unit
23819	5D0B	1	In 2 - External Display Board Input2 logical state 0: Not active 1: Active	
23820	5D0C	1	In 3 - External Display Board Input3 logical state 0: Not active 1: Active	
23821	5D0D	1	In 4 - External Display Board Input4 logical state 0: Not active 1: Active	

4.5.2.25. Setup pulse and 0/4-20mA option modules

Function 3, 6 and 16 Codes

Dec. Address	Hex. Address	Words count	Description	Unit
23888	5D50	1	OUT 1 pulse output allocation 0: kWh+ 1: kvarh + 2: kVAh 3: kWh - 4: kvarh - 5: Command	
23889	5D51	1	OUT 1 pulse output value 0: 0,1 kWh/kvarh 1: 1 kWh/kvarh 2: 10 kWh/kvarh 3: 100 kWh/kvarh 4: 1000 kWh/kvarh 5: 10000 kWh/kvarh	
23890	5D52	1	OUT 1 pulse output duration 0: 100ms 1: 200ms 2: 300ms 3: 400ms 4: 500ms 5: 600ms 6: 700ms 7: 800ms 8*: 900ms	
23891	5D53	1	OUT 2 pulse output allocation 0: kWh+ 1: kvarh + 2: kVAh 3: kWh - 4: kvarh - 5: Command	
23892	5D54	1	OUT 2 pulse output value 0: 0,1 kWh/kvarh 1: 1 kWh/kvarh 2: 10 kWh/kvarh 3: 100 kWh/kvarh 4: 1000 kWh/kvarh 5: 10000 kWh/kvarh	
23893	5D55	1	OUT 2 pulse output duration 0: 100ms 1: 200ms 2: 300ms 3: 400ms 4: 500ms 5: 600ms 6: 700ms 7: 800ms 8: 900ms	

Dec. Address	Hex. Address	Words count	Description	Unit
23894	5D56	1	Type of analog output OUT 1 0: 0/20 mA 1: 4/20 mA 2: 30 V	
23895	5D57	1	Output allocation analog OUT1 0: U12 (V) 1: U23 (V) 2: U31 (V) 3: V1 (V) 4: V2 (V) 5: V3 (V) 6: I1 (A) 7: I2 (A) 8: I3 (A) 9: In (A) 10: F (Hz) 11: $\sum P$ (W) 12: $\sum Q$ (var) 13: $\sum S$ (VA) 14: $\sum PFL$ (%) 15: $\sum PFC$ (%)	
23896	5D58	1	Value at 0 or 4 mA from analog output OUT 1 (-20000 to +20000)	-
23897	5D59	1	Unit at 0 or 4 mA from analog output OUT1 0: / 1: k 2: M	
23898	5D5A	1	Value at 20 mA from analog output OUT 1 (-20000 to +20000)	-
23899	5D5B	1	Unit at 20 mA from analog output OUT1 0: / 1: k 2: M	
23900	5D5C	1	Type of analog output OUT 2 0: 0/20 mA 1: 4/20 mA 2: 30 V	
23901	5D5D	1	Output allocation analog OUT2 0: U12 (V) 1: U23 (V) 2: U31 (V) 3: V1 (V) 4: V2 (V) 5: V3 (V) 6: I1 (A) 7: I2 (A) 8: I3 (A) 9: In (A) 10: F (Hz) 11: $\sum P$ (W) 12: $\sum Q$ (var) 13: $\sum S$ (VA) 14: $\sum PFL$ (%) 15: $\sum PFC$ (%)	
23902	5D5E	1	Value at 0 or 4 mA from analog output OUT 2 (-20000 to +20000)	-
23903	5D5F	1	Unit at 0 or 4 mA from analog output OUT2 0: / 1: k 2: M	
23904	5D60	1	Value at 20 mA from analog output OUT 2 (-20000 to +20000)	-
23905	5D61	1	Unit at 20 mA from analog output OUT2 0: / 1: k 2: M	

4.5.2.26. Setup custom time

Function 3, 6 and 16 Codes

Dec. Address	Hex. Address	Words count	Description	Unit
24064	5E00	1	Custom1 Mode 0: Not Used 1: For TON 2: For TOF	
24065	5E01	1	Custom1 Validation Type 0: By MODBUS 1: By Input 2: Auto	
24066	5E02	1	Custom1 Frequency 0: Daily 1: Weekly 2: Bi Weekly 3: Monthly 4: Yearly 5: Non Cyclic	
24067	5E03	4	Custom1 Start Time	Date Time
24071	5E07	4	Custom1 End Time	Date Time
24075	5E0B	1	Custom2 Mode 0: Not Used 1: For TON 2: For TOF	
24076	5E0C	1	Custom2 Validation Type 0: By MODBUS 1: By Input 2: Auto	
24077	5E0D	1	Custom2 Frequency 0: Daily 1: Weekly 2: Bi Weekly 3: Monthly 4: Yearly 5: Non Cyclic	
24078	5E0E	4	Custom2 Start Time	Date Time
24082	5E12	4	Custom2 End Time	Date Time
24086	5E16	1	Custom3 Mode 0: Not Used 1: For TON 2: For TOF	
24087	5E17	1	Custom3 Validation Type 0: By MODBUS 1: By Input 2: Auto	
24088	5E18	1	Custom3 Frequency 0: Daily 1: Weekly 2: Bi Weekly 3: Monthly 4: Yearly 5: Non Cyclic	
24089	5E19	4	Custom3 Start Time	Date Time
24093	5E1D	4	Custom3 End Time	Date Time
24097	5E21	1	Custom4 Mode 0: Not Used 1: For TON 2: For TOF	
24098	5E22	1	Custom4 Validation Type 0: By MODBUS 1: By Input 2: Auto	

Dec. Address	Hex. Address	Words count	Description	Unit
24099	5E23	1	Custom4 Frequency 0: Daily 1: Weekly 2: Bi Weekly 3: Monthly 4: Yearly 5: Non Cyclic	
24100	5E24	4	Custom4 Start Time	Date Time
24104	5E28	4	Custom4 End Time	Date Time
24108	5E2C	1	Genset Idle Timeout	Min

4.5.2.27. Custom time validate

Function 6 Codes

Dec. Address	Hex. Address	Words count	Description	Unit
24144	5E50	1	Custom Time1 Validate 1: Validate	
24145	5E51	1	Custom Time2 Validate 1: Validate	
24146	5E52	1	Custom Time3 Validate 1: Validate	
24147	5E53	1	Custom Time4 Validate 1: Validate	

4.5.2.28. Detailed events

Function 6 and 16 Codes

- Command Zone R1

Dec. Address	Hex. Address	Words count	Description	Unit
24320	5F00	1	Action 0x0001: Reset read pointer 0xFFFE: Get next data	
24321	5F01	1	Filtering action - If not written, no filtering is done To use filtering, entire table should be written in one time with function 16 0x00XX: only get events in the form XXyy 0xFFFF: no filter	

Function 3 Codes

- Data Zone R2

Dec. Address	Hex. Address	Words count	Description	Unit
24336	5F10	1	record count If record count == 0xFFFF, it means that filtering process is not done now, so the reader has to re-read the table to get the values.	
24337	5F11	1	record size If record size == 0xFFFF, it means that filtering process is not done now, so the reader has to re-read the table to get the values.	nb words
		120	8 * Event data record	

Function 3 Codes

• Data record description

Dec. Address	Hex. Address	Words count	Description	Unit
0	0	1	Event ID 0x8000: Power On 0x8001: Power Off 0x8002: Power Off prevent 0x8003: Power main overvoltage 0x8004: Power main undervoltage 0x8005: Power aux overvoltage 0x8006: Power aux undervoltage 0x8100: Configuration changed 0x8101: Configuration save failed 0x8102: Configuration load failed 0x8105: Configuration date saved 0x8106: Configuration date save failed 0x8107: Configuration date read failed 0x8110: Configuration calibration read failed 0x8300: User reset 0x8301: Watchdog reset 0x8302: Date resynchronized 0xFF00: Software version changed 0x0001: Source 1 Lost 0x0002: Source 1 comes back 0x0003: Source 1 not started (1ST / 2ST) 0x0004: Source 1 Undervoltage 0x0005: Source 1 Overvoltage 0x0006: Source 1 Unbalanced 0x0007: Source 1 Underfrequency 0x0008: Source 1 Overfrequency 0x0009: Source 1 Rotation fault 0x000A: Source 1 Neutral fault 0x000B: External fault with zero return source 1 0x000C: External fault without zero return source 1 0x000D: Source 1 Overload 0x0101: Source 2 Lost 0x0102: Source 2 comes back 0x0103: Source 2 not started (2ST) 0x0104: Source 2 Undervoltage 0x0105: Source 2 Overvoltage 0x0106: Source 2 Unbalanced 0x0107: Source 2 Underfrequency 0x0108: Source 2 Overfrequency 0x0109: Source 2 Rotation fault 0x010A: Source 2 Neutral fault 0x010B: External fault with zero return source II 0x010C: External fault without zero return source II 0x010D: Source 2 Overload 0x0201: Test on load start 0x0202: Test on load end 0x0203: Test on load failed 0x0204: Test off load start 0x0205: Test off load end 0x0206: Test off load failed 0x0207: External order on load start 0x0208: External order on load end 0x0209: External order on load failed 0x020A: External order off load start 0x020B: External order off load end 0x020C: External order off load failed 0x020D: Battery charger start 0x020E: Battery charger end 0x020F: Unlimited TOF/TON stopped because of communication timeout 0x0301: Automatic switch to position 0 0x0302: Automatic switch to position I 0x0303: Automatic switch to position II 0x0304: Manual switch to position 0	

Dec. Address	Hex. Address	Words count	Description	Unit
0	0	1	0x0305: Manual switch to position I 0x0306: Manual switch to position II 0x0307: Remote controlled switch to position 0 0x0308: Remote controlled switch to position I 0x0309: Remote controlled switch to position II 0x030A: Operating Factor Fault 0x030B: Position 0 not reached 0x030C: Position I not reached 0x030D: Position II not reached 0x030E: Unexpected switch to pos 0 when in auto mode 0x030F: Unexpected switch to pos I when in auto mode 0x0310: Unexpected switch to pos II when in auto mode 0x0311: Unexpected switch to pos 0 when in locked mode 0x0312: Unexpected switch to pos I when in locked mode 0x0313: Unexpected switch to pos II when in locked mode 0x0401: Input/Output configuration changed 0x0402: Application/Timers configuration changed 0x0403: Sources (thresholds) configuration changed 0x0404: Communication configuration changed 0x0405: HMI configuration changed 0x0406: Network configuration changed 0x0407: Option modules configuration changed 0x0408: Date/Time configuration changed 0x0409: Default configuration loaded 0x040A: User backup configuration loaded 0x040B: User backup configuration saved 0x040C: Product autoconfiguration requested 0x040D: Product autoconfiguration done 0x040E: Product autoconfiguration failed 0x0501: 1FT - Primary Source fail timer 0x0502: 1RT - Primary Source availability/stabilization timer 0x0504: 1OT - Primary Source return to 0 timer 0x0508: 2FT - Secondary Source fail timer 0x0509: 2RT or 2AT - Secondary Source availability/stabilization timer 0x050A: 2CT - Secondary Source maintain request timer (cooldown timer) 0x050B: 2OT - Secondary Source return to 0 timer 0x050C: 2ST - Secondary Source wait for start timer 0x050D: EET - Secondary Source battery charger timeout 0x050E: EDT - Secondary Source battery charger duration 0x050F: ODT - Dead band timer 0x0510: TON - Test on load duration timer 0x0511: T3T - Test on load end timer 0x0512: TFT - Test off load duration timer 0x0513: E1T - Time before external order on load 0x0514: E3T - Time after external order on load 0x0515: E2T - External order on load duration 0x0516: E5T - Time before external order off load 0x0517: E7T - Time after external order off load 0x0518: E6T - External order off load duration 0x0519: LS_ON - LoadShedding_On Timer 0x051A: LS_OFF - LoadShedding_Off Timer 0x051B: LSB (between 100 ms and 9999 ms) 0x051C: StartGen idle timer 0x0608: Product becomes available 0x0609: Product becomes unavailable 0x060A: Product becomes inhibited 0x060B: Product no more inhibited 0x0701: Source 1 EA+ counter reset 0x0702: Source 1 EA- counter reset 0x0703: Source 1 EQ+ counter reset 0x0704: Source 1 EQ- counter reset 0x0705: Source 1 ES counter reset 0x0706: Source 1 Time meter reset	

Dec. Address	Hex. Address	Words count	Description	Unit
0	0	1	0x0707: Source 2 EA+ counter reset 0x0708: Source 2 EA- counter reset 0x0709: Source 2 EQ+ counter reset 0x070A: Source 2 EQ- counter reset 0x070B: Source 2 ES counter reset 0x070C: Source 2 Time meter reset 0x070D: Start order count reset 0x070E: Start order active duration reset 0x070F: Secondary source duration reset 0x0710: Secondary source active duration reset 0x0711: Source 1 load supplied duration reset 0x0712: Source 2 load supplied duration reset 0x0801: Load shedding request activated 0x0802: Load shedding request deactivated 0x0901: Configuration n°1 active 0x0902: Configuration n°1 validated 0x0903: Configuration n°1 active 0x0904: Configuration n°1 validated 0x0905: Configuration n°1 active 0x0906: Configuration n°1 validated 0x0907: Configuration n°1 active 0x0908: Configuration n°1 validated 0x1001: Read indus area failure 0x1002: Write indus area failure 0x1003: Read serial number failure 0x1004: Write serial number failure 0x1101: Customization load error 0x1102: BET in default 0x1103: BET not present 0x1104: Load context failure 0x1105: StartGen relay fault 0x1106: RTC fault 0x1107: Internal display board detection error 0x1108: External display board detection error 0x1109: 2IN/2OUT option module #1 no more detected 0x110A: 2IN/2OUT option module #2 no more detected 0x110B: 2IN/2OUT option module #3 no more detected 0x110C: 2IN/2OUT option module #4 no more detected 0x110D: External display detection error 0x110E: I2C Fault	
1	1	1	Type 0: State 1: Edge 2: System	
2	2	1	Severity 0: none 1: information 2: warning 3: default	
3	3	1	Satus 0: non active 1: active 2: finished 3: new & checked 4: finished & checked	
4	4	4	Start Date	ms since 1 jan 2000
8	8	2	Duration	ms
10	A	1	Cause	-
11	B	2	Value 1	-
13	D	2	Value 2	-

5. PREVENTATIVE MAINTENANCE

Yearly inspection will insure better reliability and longer lifetime of the equipment. The following annual preventive maintenance operations are recommended.

- Clean the equipment enclosure.
- Operate a manual changeover on each integrated product Q1, Q2, Q3 and on the ATS.
- Check the tightening of all cable connections (tightening campaign recommended).
- Check that ventilation extraction systems are not obstructed and clean the filters.

6. PROCEDURE FOR EXTRACTING THE AUTOMATIC SWITCH

6.1. 40 to 125 A

- Bypass and isolate the automatic switch following the instructions on page 43
- Unlock handles Q1 and Q3 if the automatic switch is bypassed by source S1 (see opposite for unlocking instructions)
- Unlock handle Q3 only if the automatic switch is bypassed by source S2 (see opposite for unlocking instructions)
- Open the enclosure door
- «Unplug» the control section of automatic switch Q4
- Remove the RJ45 cable
- Remove the S1/S2/Load power cables using a \varnothing 4 mm Allen key
- Remove the cables from the auxiliary contact to the right of automatic switch Q4 after having ensured that the auxiliary circuits are isolated
- Remove the 4 screws (H, M6) from the base plate.
- Detach the plate to allow you to remove the plate + automatic switch assembly

6.2. 160 A

- Bypass and isolate the automatic switch following the instructions on page 43
- Unlock handles Q1 and Q3 if the automatic switch is bypassed by source S1 (see opposite for unlocking instructions)
- Unlock handle Q3 only if the automatic switch is bypassed by source S2 (see opposite for unlocking instructions)
- Open the enclosure door
- Check that fuse holders F1 and F2 are open.
- Remove the PVC screen using a size 8 wrench (M5 screw)
- «Unplug» the control section of automatic switch Q4
- Remove the RJ45 cable
- Remove the S1/S2/Load power cables
- Remove the 4 screws (H, M6) from the automatic switch base plate
- You can remove the automatic switch.



Note: after refitting the automatic switch, it is advisable to run Off Load & On Load tests following the instructions on page 49 for Double Line and page 51 for Single Line.

6.3. 250 A / 400 A / 630 A

- Bypass and isolate the automatic switch following the instructions on page 52
- Open the enclosure's right-hand door
- Check that fuse holders F1 and F2 are open.
- Remove the PVC screen using a size 8 wrench (M5 screw)
- «Unplug» the control section of automatic switch Q4
- Remove the RJ45 cable
- Remove the S1/S2/Load power cables
- Remove the 4 front bars (S1) under automatic switch Q4 (H, M10)
- Remove the bolts from the rear bars (S2) under automatic switch Q4 (H, M10)
- Remove the bolts from the horizontal bars (Load) connected to automatic switch Q4 (H, M10)
- Loosen the 2 slide retaining screws (see diagram below)
- Remove the slide
- If necessary, you can then remove automatic switch Q4 from its plate.

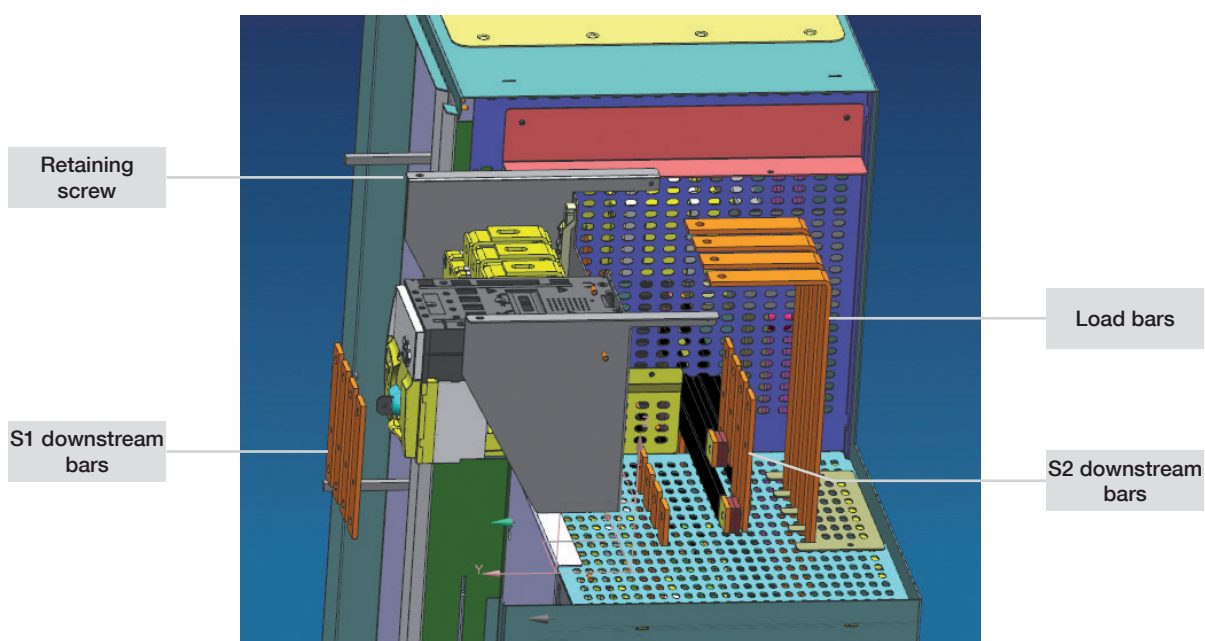

 Note: after refitting the automatic switch, it is advisable to run Off Load & On Load tests following the instructions on page 49 for Double Line and page 51 for Single Line.

6.4. Unlocking the door in positions I and II

WARNING

DANGEROUS VOLTAGE. Switch off the power before performing work. Ensure that the enclosure is closed before moving the device. The tests on powered equipment must only be carried out by qualified personnel. Failure to follow these instructions will result in death or serious injury.

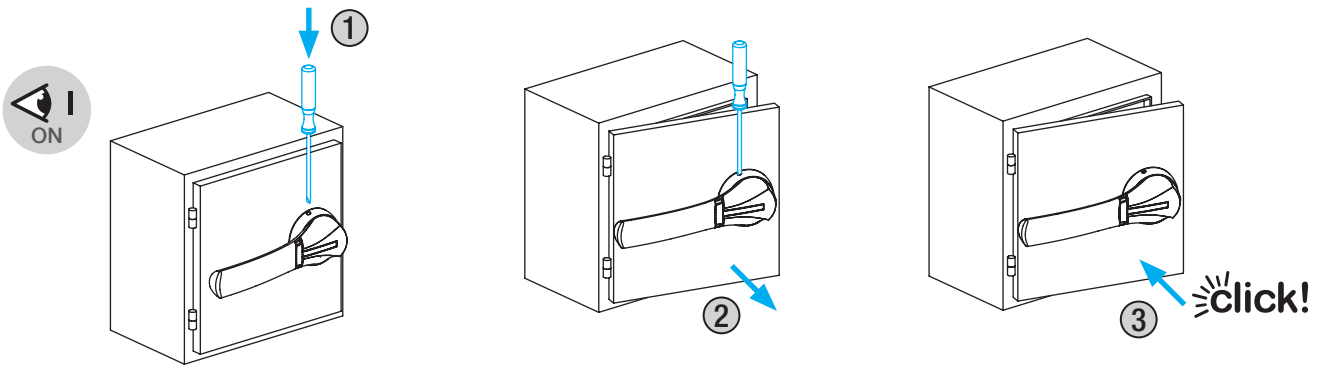

CORPORATE HQ CONTACT:
SOCOMECSAS
1-4 RUE DE WESTHOUSE
67235 BENFELD, FRANCE

www.socomec.com

Non contractual document. © 2023, Socomec SAS. All rights reserved.
Print: 80g^m - A5 Folded - R/V - B&W - with staples in the middle.



541659F



 **socomec**
Innovative Power Solutions